

Trimble Technology  
Solutions for your  
**CONNECTED  
CONSTRUCTION  
SITE**



The experienced construction professionals at SITECH® will show you how to leverage Trimble construction technology solutions, including:

- Machine Control
- Site Positioning Systems
- Construction Asset Management Services
- Construction Software

Learn how easy it is to utilize construction technology that makes significant improvements in project workflow, dramatically increases your production, improves your accuracy and lowers your operating costs through reduced survey costs, moving dirt right the first time, improved material yields, increased fuel savings and reduced operating time. With the addition of Trimble solutions to your construction projects, you're in a more powerful competitive position in the marketplace. Whether you choose to start small or go big, the expanded capability will enable you to earn the bid and be more profitable, project after project.

## GLOBAL REACH + LOCAL SUPPORT

SITECH is a global distribution network for Trimble solutions—the most reliable and rugged construction technology systems available to the heavy civil construction contractor. The stability and experience of a local partner combined with the best construction technology available from Trimble. The experienced construction professionals at SITECH provide:

- Local customer service and sales
- Installation services
- Personalized training
- Technical support

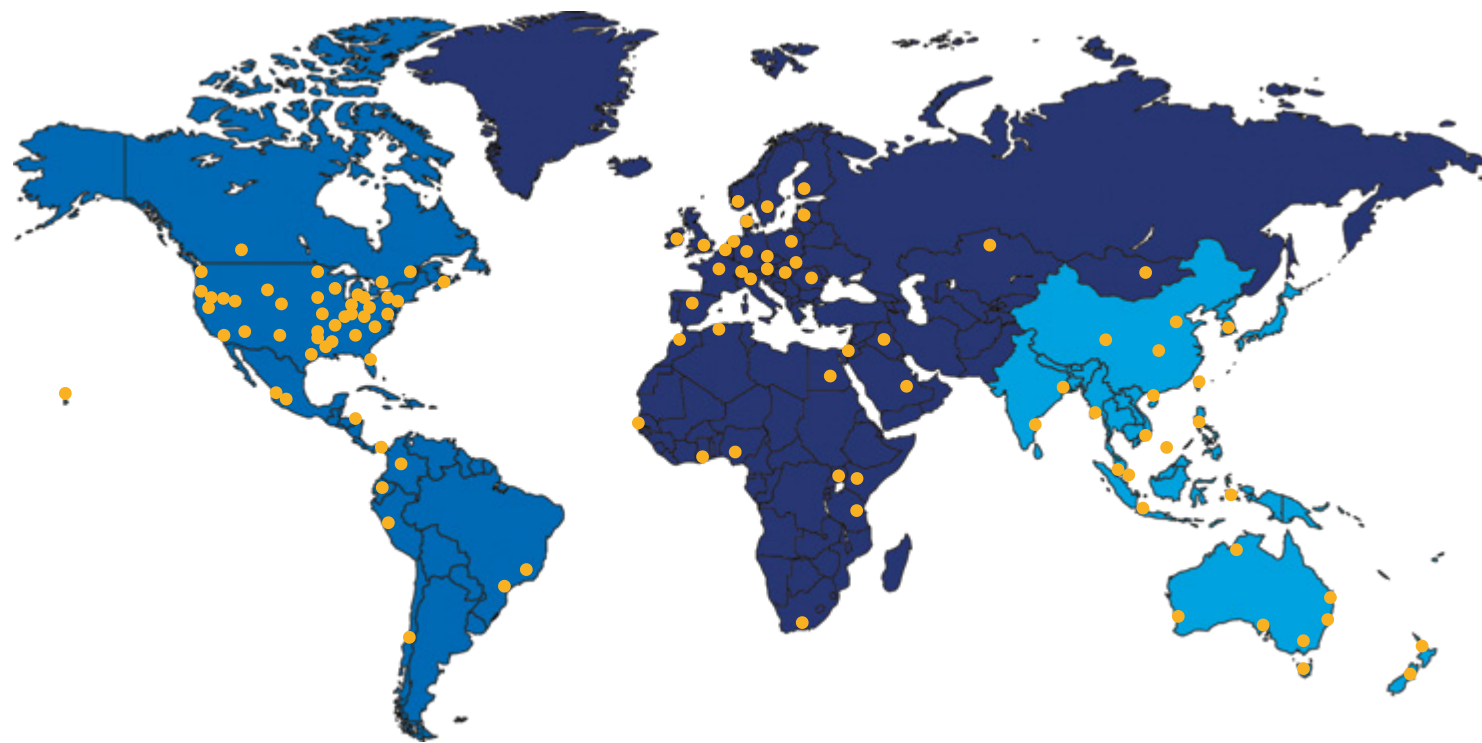

Improve efficiency and productivity, while minimizing waste and expense throughout the life of the project with Trimble® Connected Site® solutions for earthworks. Create a 3D constructible model, use it to plan the most cost-effective schedule, and then use the same model to track project progress.

## SURVEY THE SITE

Collect survey data, grade check, and as-built data from the field and send it to the office in real-time to build an accurate 3D constructible model for takeoff estimating, data preparation and reporting. Or take advantage of fast and safe aerial data collection with Trimble Stratus Software to replace ground surveys and provide more data at shorter intervals for lower overall cost.

With field software designed specifically for construction workflows and seamless integration with other Trimble software solutions, job site delays and rework are significantly reduced. Easy-to use and learn field software means you spend less time training and preparing data, and more time getting the job done.

## BUILD A 3D CONSTRUCTIBLE MODEL

Combining current field conditions from multiple sources with design information provides the foundation for the 3D constructible model. Validate and improve the site operations plan with a 3D constructible model, so you know what to build and where to build it before costly construction begins. Adding intelligence to the model, such as how dirt will be moved, and updating the model with up-to-date field information makes the constructible model a powerful tool to plan, manage and construct projects.

## SYNC REAL-TIME DATA WIRELESSLY

The 3D constructible model is used to automatically sync design files and work orders between the office and the field in real-time so everyone is working with the latest files.

When up-to-date design information can be sent to the field crews or machine operators without leaving the office, you get 100% less drive time, and 100% less rework, 100% of the time.



## SUPPORT AND TRAIN REMOTELY

Get real-time technical support for field crew personnel or earthworks machine operators, without the time and cost of waiting for a technician to drive to the construction site. Both the field crews and the support team see the same picture, eliminating costly delays, downtime and drive time.

## TRACK AND REPORT PROGRESS

Intelligently combining as-constructed information from across the project allows for advanced, near real-time reporting for progress payments. As-built progress can be monitored as the machines move dirt, and QA reporting and stakeout results can be generated. By combining both

survey and machine data, contractors get the best overall picture of the current state of the project. In addition, soil compaction operations can be monitored to ensure compaction requirements are being met.

## COLLABORATE EFFECTIVELY

All your important files for the whole team are now located and backed up securely in the cloud. Overlay designs and cut/fill maps onto Google Maps or digital imagery, so everyone can see what's happening. Even site inspections and routine site visits are easily recorded and uploaded – including photos.

# MACHINE CONTROL

## BENEFITS



Trimble has worked with many machine manufacturers to reduce the time spent on installation of Trimble machine control. Trimble Ready® machines ship from the factory ready for installation of Trimble components, which can significantly reduce the cost and complexity of the installation for the contractor. By making it faster and less expensive to install Trimble technology, contractors can now realize an even quicker return on investment from their Trimble equipment. Ask your local heavy equipment dealer if the Trimble Ready option is available for your new machine.

**PRODUCTION**  
**INCREASED BY**  
**100%**

**INCREASED**  
**JOB SAFETY**



**98%**  
**ON GRADE**  
**ACCURACY**

**43%**  
**SAVINGS IN**  
**DIESEL FUEL**

“ K & E has 25 – 30 pieces of equipment set-up with SITECH. We pull slopes, dig ditches . . . everything. It's a big investment, but we get it back very quickly because you have accuracy, you have productivity, you make more profit, you can get so much more done because you're running the machine at 100% efficiency. I think our return on it is a year or less. I feel Trimble equipment is top notch. We couldn't be happier – it's the only way to go.

KERRY KUENZI, PRESIDENT – K & E EXCAVATING, INC. • SALEM, OR



# PROVEN COMPONENTS

## THE RIGHT FIT FOR EVERY JOB

### DISPLAYS AND CONNECTIVITY

#### Trimble SNM941 Connected Site Gateway

Connect your machine with rugged hardware from Trimble. Featuring both Wi-Fi and cellular connectivity, the SNM941 enables wireless data transfer of design files and GNSS corrections, and fleet, asset and site productivity information.



#### Trimble CB460 Control Box

Designed for use in harsh construction environments, the Trimble CB460 display is part of the GCS900 Grade Control System and gives the operator a full-color graphical display for easy viewing and guidance to grade.

The CB460's key features are:

- A large, easy-to-read 7" (17.78 cm) full-color LCD display
- Faster data transfer via Ethernet connection
- Audible tones for real-time grade guidance or warnings and alerts
- Four LED light bars to provide grade guidance at a glance and support for external light bars



### 2D COMPONENTS

#### Spectra Precision GL700 Series Grade Laser

Spectra Precision® GL722 Series Grade Lasers provide years of durable, precise machine guidance with Trimble 2D Grade Control Systems and laser-based compact machine installations. Ideal for site preparation, trenching and pipe laying, fine grading and road construction, the GL700 lasers can help you get to grade faster with more accuracy.



#### Trimble LR410 Laser Receiver

The LR410 is mounted to an electric mast on the blade and connected to the machine hydraulics to control lift to an accuracy of 0.01 to 0.02 feet (3-6 millimeters).



#### Trimble ST400 Sonic Tracer

The ST400 is mounted to the blade and uses a physical reference such as curb and gutter, stringline, existing or previous pass as an elevation reference.



#### Trimble TD510 and TD540 Displays

The 10-inch (25.4 cm) TD540 and 7-inch (17.78 cm) TD510 displays ensure the best user experience with the Trimble Earthworks Grade Control Platform. With a specialized combination of anti-glare, powerful backlighting and advanced optical bonding techniques, these rugged displays combine at-a-glance sunlight readability with an easy to use, multi-touch interface. Built on top of a powerful 3D graphics engine and processing platform, the Android™ operating system allows you to install additional applications without upgrading hardware or adding an additional display.



Features include:

- Powerful octa-core processor platform with dedicated graphics processor
- Integrated Bluetooth® and Wi-Fi for wireless connectivity
- Quick release RAM mounting for daily theft protection removal
- Front facing USB for easy firmware updates and synchronization of design and productivity data

### 3D COMPONENTS

#### Trimble MS996 GNSS Smart Antenna

The MS996 contains an integrated GPS+GNSS receiver, antenna, and isolation system all in a single, durable housing. It uses the advanced Trimble RTK engine for faster initialization times when satellite lock is lost and enhanced performance near obstructions.



#### Trimble MS976 GNSS Smart Antenna

The MS976 offers a cost-effective alternative for contractors who need a highly accurate GNSS receiver at a lower price point. It is optimized for cab or machine body mount only.



#### Trimble SNR On-Machine Radios

Rugged Trimble on-machine radios offer a modernized platform for communicating with Trimble Universal Total Stations or with a fixed GNSS base station. Available in:

- Single-band 450 MHz, 900 MHz, and 2.4 GHz
- Dual-band 900 MHz + 2.4 GHz and 450 MHz + 2.4 GHz



#### Trimble Total Stations

Trimble SPS Series Universal Total Stations can be used for even greater accuracy when performing fine or finished grading, with blade guidance to 0.007 to 0.016 feet (2-5 millimeters).



YOUR CONSTRUCTION TECHNOLOGY PROVIDER

# TRIMBLE EARTHWORKS

CONTROL THE FUTURE

The Trimble Earthworks Grade Control Platform offers groundbreaking features. It is designed to help you do more in less time. State-of-the-art software and hardware give operators of all skill levels the ability to work faster and more productively than ever before.

## INTEGRATES WITH TRIMBLE WORKSMANAGER AND TRIMBLE WORKSOS SOFTWARE

Trimble WorksManager is a mobile-friendly software that easily manages data and technology assets across project sites. It allows you to transfer data files to or from the office wirelessly, automatically ensuring everyone is operating from the latest design. Trimble WorksOS monitors live earthmoving and compaction volume metrics, so you can see exactly how much work has been completed, and how much remains. Stay on schedule and work more efficiently with Trimble Software solutions, designed to make construction management easier on and off the job site

## TRIMBLE EARTHWORKS ASSISTANT APP

The Trimble Earthworks Assistant App is a stand-alone app that consolidates and simplifies access to training guides and videos inside and outside of the cab. It makes it easy to learn and troubleshoot using an Android cell phone, even from remote sites. The user has access to critical Trimble Earthworks learning material and documentation, allowing for a shorter learning curve and less downtime for operators.

\*Available on the Google Play Store

# MACHINE CONTROL REDEFINED

## INTUITIVE SOFTWARE

The software was created in collaboration with construction equipment operators around the world, so the interface is optimized for ease-of-use and productivity.

- Colorful graphics, natural interactions and gestures, and self-discovery features make Trimble Earthworks intuitive and easy to learn
- Each operator can personalize the interface to match their workflow using a variety of configurable views
- Files can be transferred to or from the office wirelessly and automatically so you've always got the latest design



## SUBSCRIBE NOW

Now available in a subscription model with flexible terms to modernize your equipment with no large upfront cost.



## THE KEY COMPONENTS

- 10" or 7" touch 3D Color-Display
  - Gorilla® Glass
  - Best visibility even in bright sunlight
- Android operating system

## TRIMBLE EC520 ELECTRONIC CONTROLLER

- The processing unit is separated from the display and is permanently installed on the machine
- Integrated Inertial Measurement Unit (IMU) body sensor with 6 degrees of freedom
- Optional integrated Wi-Fi for on machine wireless connectivity to displays, laptops, hot spots or mobile devices
- 4 GB internal memory for machine data and designs



## TRIMBLE GS520 GRADE SENSOR

- Six degrees of freedom inertial measurement unit, based on the latest inertial sensor technology and particularly responsive
- 100Hz, 3x axle pitch, 3x axle acceleration
- Compact form factor: Mount in any orientation
- Excavator bucket, dozer and grader blades
- Precision locating feature for positioning and re-positioning



# TRIMBLE EARTHWORKS FOR EXCAVATORS

INTRODUCING UNDERTIME

Trimble Earthworks for excavators was the first aftermarket semi-automatic bucket and boom control system and gives your operation many competitive advantages so you can finish on-time and on-budget.

## AUGMENTED REALITY

With the Augmented Reality feature available in Trimble Earthworks for excavators, operators can view 3D models in a real-world environment at a true-life scale, in the context of existing surroundings. Augmented Reality simplifies complex concepts by allowing users to work faster and safer using a blend of digital content and real-world environments.

## TILTROTATOR SUPPORT

Trimble Earthworks works with tilt automatics on engcon®, Rototilt®, and Steelwrist® attachments. The system controls the boom and bucket of the excavator as well as the tilt angle of the attachment, while the operator controls the stick of the excavator and rotation of the tiltrotator.

## PAYLOAD MANAGEMENT INTEGRATION

Trimble Earthworks has the option to display grade control and accurate payload data on one screen. Increase your mass haul productivity and efficiency by preventing underloading, and improving safety by avoiding overloading. Track productivity with the optional Bluetooth® printer and web-based reporting.



# VARIOUS CONFIGURATIONS

ACCORDING TO YOUR NEEDS

**2D CONFIGURATION FOR DEPTH AND SLOPE** - Flexible starter solution for excavation, canal and trench construction, grading and profile work—the start of productivity.

**3D SINGLE OR DUAL GNSS OR UTS CONFIGURATION** - Powerful 3D control system to measure the exact position of the bucket for more complex grading and excavation tasks.

**AUTOMATIC GUIDANCE** - Available for a broad range of machine brands and models, the automatic system controls the hydraulics of the machine and achieves high precision in flat or inclined surfaces. With the benefits of automatic functionality, increase the productivity of your machine up to 40%.

### How it works:

1. The excavator is placed in auto mode
2. The operator controls the stick
3. Trimble Earthworks controls the boom and bucket
4. Stay on grade, reduce overcut and increase production

## CORE SYSTEM

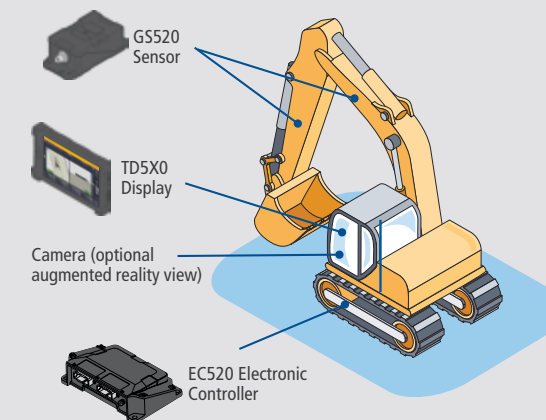

## AUTOMATICS SYSTEM

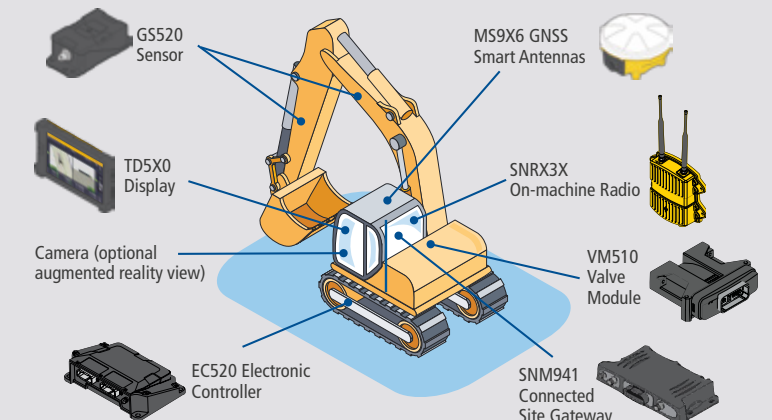

## DUAL/SINGLE GNSS SYSTEMS

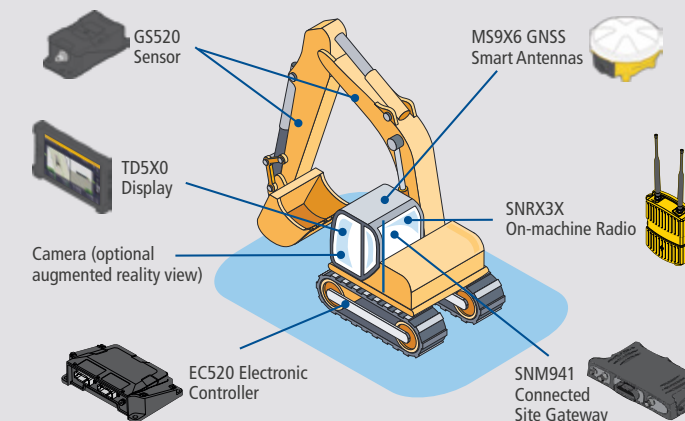

## UNIVERSAL TOTAL STATION SYSTEM

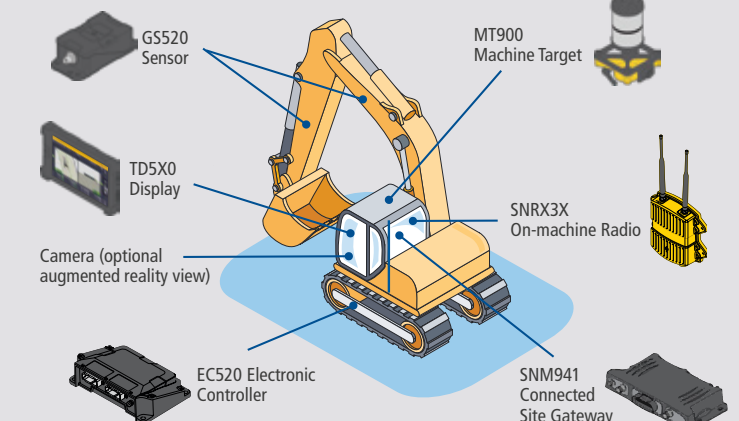

# TRIMBLE EARTHWORKS FOR DOZERS

CONTROL THE FUTURE

Trimble Earthworks offers dozer operators the flexibility to choose between cab-mounted portability and the blade mount configurations for the supported models.



# MACHINE CONTROL REDEFINED

## FOCUS ON GRADE

Horizontal Steering Control for dozers automatically controls the machine to follow any horizontal alignment such as a back of a curb, breakline, roadway centerline or bottom of slope, without operator assistance. Operators can also manually set up offsets from selected alignments that the machine can follow.

Horizontal Steering Control allows the operator to focus on the grade, machine productivity and safety rather than worrying about steering, which reduces operator fatigue and errors. It enables the machine to follow the horizontal guidance from the 3D model, providing operators increased awareness of their surroundings, better accuracy and improved productivity with decreased overlap and fewer passes.



## BLADE MOUNT DUAL GNSS SUPPORT

The blade mount dual GNSS configuration allows for a broader range of supported dozer models. This enables older machine models in the fleet to have Trimble Earthworks guidance and control for the operator. The Blade-Mount GNSS only supports Dual GNSS.

## CAB-MOUNTED PORTABILITY

Trimble Earthworks for Dozers mounts dual GNSS receivers on top of the cab to eliminate masts and cables traditionally located on the blade. The dual GNSS receivers are ideal for steep slope work and complex designs with tight tolerances.

This configuration allows you to easily move the receivers to other machines, to maximize your investment and keep your machines working. Cab-mounting receivers is more convenient and can save you time by reducing the need to reinstall them each day.

## UNIVERSAL TOTAL STATION SYSTEM

For supported cab mount GNSS models, the high precision blade mount options for laser and UTS expand the capabilities of the machine control system to operate in GNSS obstructed environments and tasks requiring higher precision than a GNSS guided solution.

## CAB-MOUNTED DUAL GNSS SYSTEM

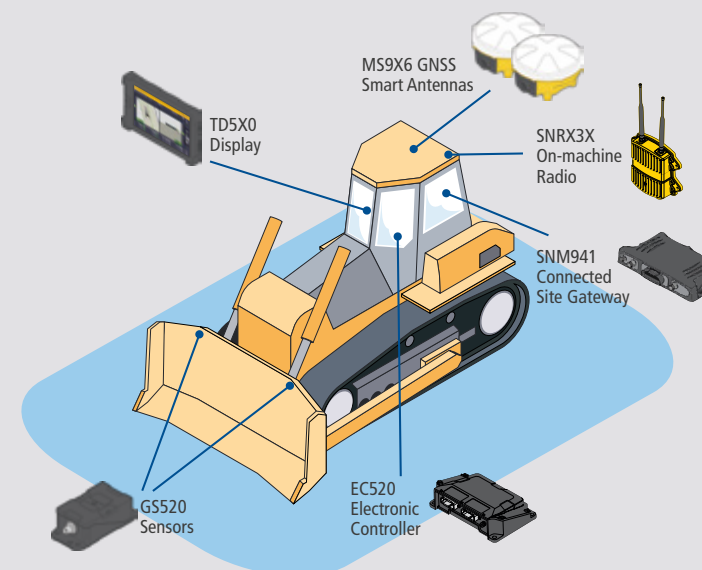

## UNIVERSAL TOTAL STATION SYSTEM

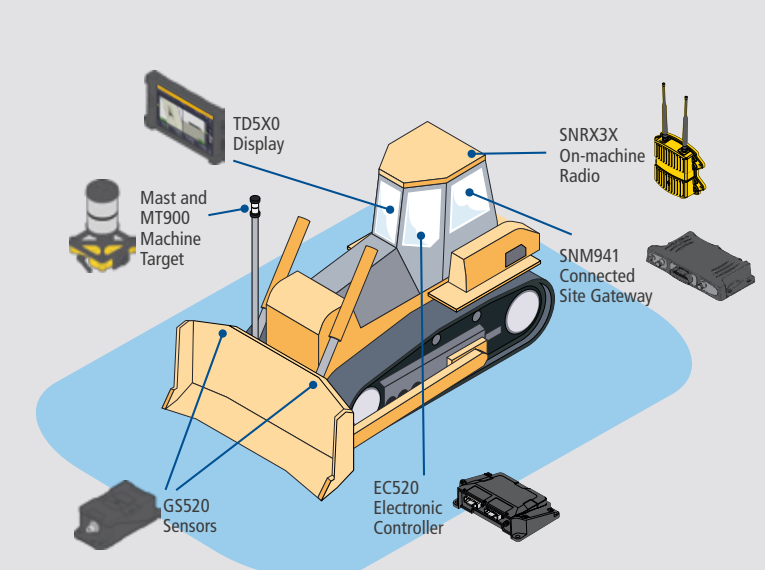

# TRIMBLE EARTHWORKS FOR GRADERS

RUNNING ON TIME

Trimble Earthworks for motor graders helps operators of all levels leave a quality surface. This next generation system with a familiar Android UI, and user-friendly 10-inch touch screen cuts the learning curve, improves operator capabilities, and gives you a first-pass finish that's second to none.



# LEAVE A FINISHED GRADE

THE FIRST TIME, EVERY TIME

## SINGLE / DUAL GNSS ACCURACY

Dual GNSS provides real-time position and heading of the machine for guidance of the motor grader blade in 3D, enabling faster reaction times and enhanced performance. The IMU-based system offers even better GNSS performance, for more accuracy and stability. The platform supports multiple correction services, including VRS and Internet Base Station Service (IBSS). And when a correction source is temporarily unavailable, the Trimble xFill™ feature will fill in the gaps to maximize up-time.

## LEGENDARY PRECISION WITH UTS

Trimble Earthworks for motor graders with Trimble Universal Total Stations is THE configuration for finish grading with fewer passes. Contractors can place finished grade materials more accurately and in a shorter time period, keeping material costs to a minimum and improving productivity.

## MASTLESS FLEXIBILITY

Trimble Earthworks for motor graders enables a mastless GNSS configuration for supported Cat® motor grader models. This mounts one GNSS receiver on the cab and the second GNSS on the gooseneck of the machine to eliminate masts and cables traditionally located on the blade. The mastless GNSS configuration is ideal for applications to enable the blade's maximum range of motion such as steep slope work and complex designs that need to be built to tight tolerances. It also decreases risk of damage to the machine and reduces the time needed to remove and reinstall GNSS receivers each day.

### BLADE-MOUNTED DUAL GNSS SYSTEM

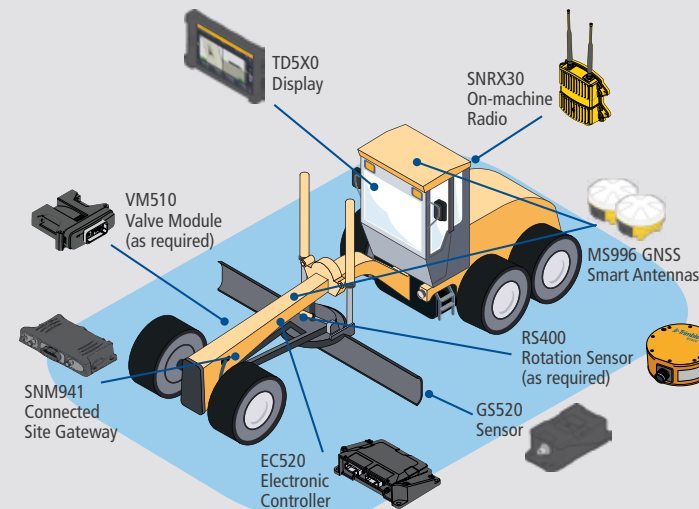

### MASTLESS DUAL GNSS SYSTEM

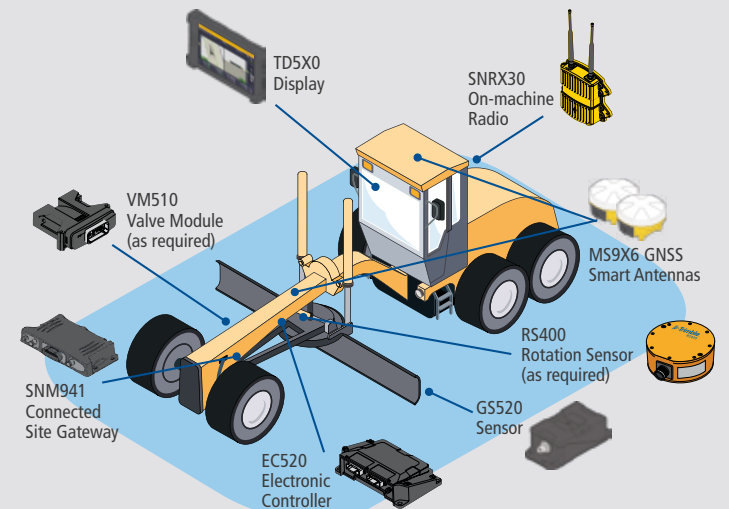

Note: Position Sensing Cylinder required for the motor grader sideshift ram

### BLADE-MOUNTED SINGLE GNSS SYSTEM

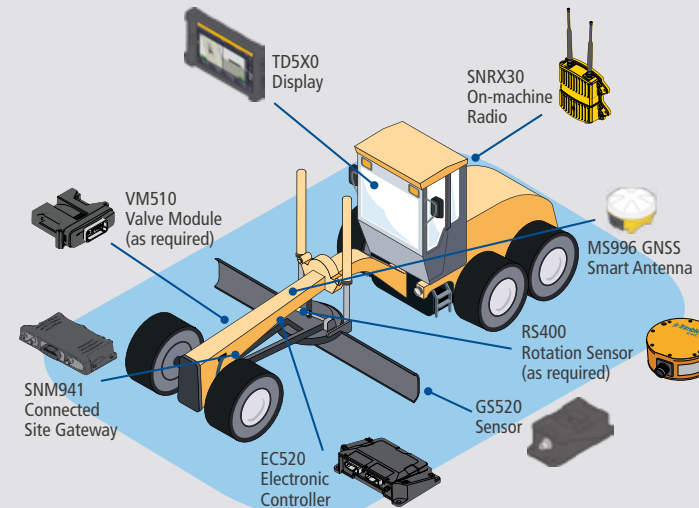

### UNIVERSAL TOTAL STATION SYSTEM

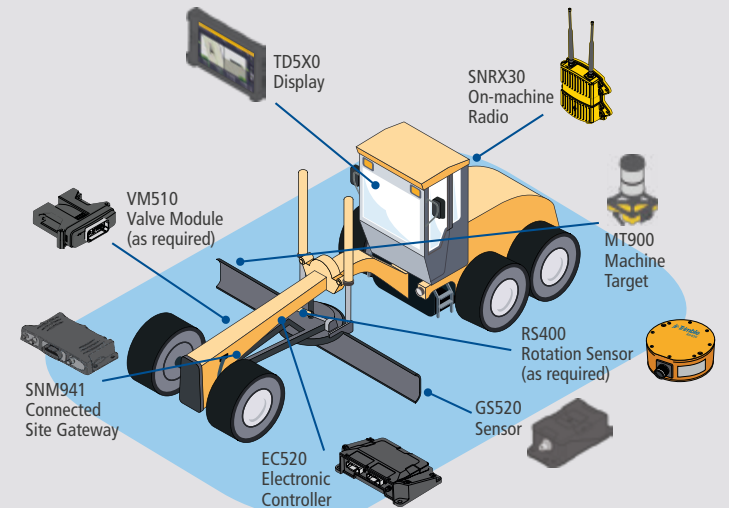

# TRIMBLE EARTHWORKS FOR COMPACT MACHINES

Trimble Earthworks is also available for compact grading attachments with Single/Dual GNSS, Single/Dual Laser, Single/Dual Sonic and Total Station guidance options. A tailored 3D solution for applications such as site projects where full size grading machines are unable to operate in the confined environment or for the contractor looking to expand opportunities for 3D machine control jobs.

The operator UI remains consistent with larger machines

- Compact loader and attachment icons for the brand of grading attachment
- Supports Trimble TD5X0 Display and BYOD
- Office and in-field design support

Dedicated software license options and alternative hardware configurations allow for easier installation at lower expense.



# SMALL MACHINES, BIG POTENTIAL

## MADE FOR YOUR SMALL MACHINES

Trimble Earthworks for Compact Machines delivers on the needs of your small machines.

Offering a wireless connection to the machine display for maximum flexibility, as well as compact machine-specific interface elements, Trimble's latest offerings will help you maximize the productivity of your small equipment.

## OPTIONS TO GET THE JOB DONE RIGHT

Trimble Earthworks for compact machines gives you a variety of sensor options to meet the needs of your next job.

Offering GNSS based systems, as well as universal total station and laser options, we have what you need whether flexibility or the ultimate level of precision is your goal.

### BLADE-MOUNTED DUAL/SINGLE GNSS SYSTEM

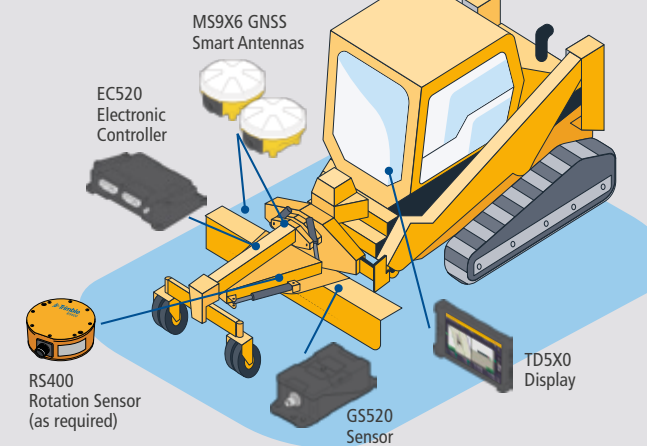

### DUAL/SINGLE LASER SYSTEM

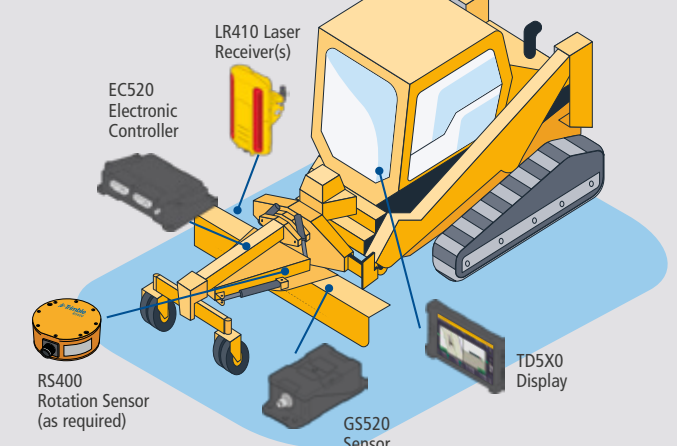

### UNIVERSAL TOTAL STATION SYSTEM

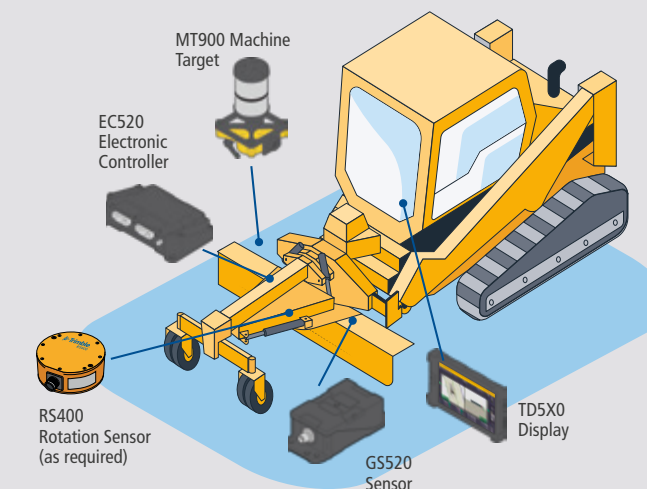

### DUAL/SINGLE SONIC SYSTEM

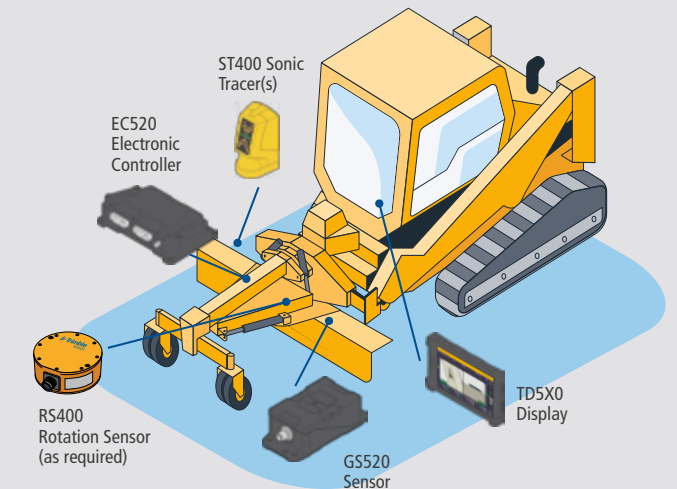



# TRIMBLE EARTHWORKS

## GRADE CONTROL PLATFORM FOR SOIL COMPACTORS

The Horizontal Steering Control feature is available on an increasing number of machine brands and models. The next generation Android UI system with a large, friendly touch screen enables you to easily view compaction progress and pass counts, as well as optionally view and record the compacted soil stiffness.



Trimble Earthworks supports 4-drum landfill compactors. The Landfill Compaction Algorithm (LCA) gives operators the ability to configure multiple compaction parameters. It helps avoid unnecessary passes that waste time and fuel, and alleviates thick layer material placement that leads to insufficient compaction. LCA allows contractors to customize the system to the characteristics of the site, allowing users to define their own best practices for a more efficient landfill operation.

# FOR A PERFECT FINISH

## INTELLIGENT COMPACTION

Trimble Earthworks for soil compactors enables contractors to accurately control the compaction process, while reducing unnecessary passes that result in over compaction. The system achieves compaction target faster, more accurately and with less rework.

- Compact surface material to the desired compaction stiffness target and monitor site volumes simultaneously, in real time
- Soil and sub-surface material compaction measurement for single smooth drum and pad foot rollers
- Achieve increased durability, stability and load-bearing capacity

## HORIZONTAL STEERING CONTROL

The Horizontal Steering Control feature automatically controls the machine to follow any horizontal alignment such as a back of a curb, breakline, roadway centerline or bottom of slope, without operator assistance. Operators can also manually set up offsets from selected alignments that the machine can follow.

It enables the machine to follow the horizontal guidance from the 3D model, providing operators increased awareness of their surroundings, better accuracy and improved productivity with decreased overlap and fewer passes.

## ACTIONABLE DATA

Supervisors and quality managers can monitor compaction activities in real-time, and operators can immediately identify the areas that require further compaction using Trimble WorksOS Software and Trimble Earthworks.

- Collect and document comprehensive, real-time compaction data
- Analyze data in the office to generate detailed reports and documentation to meet project specifications
- Continuously monitor pass counts and compaction measurement values (CMV) over the entire area
- Improve testing success, reduce rework and lower ongoing maintenance costs
- Reduce over-compaction to optimize fuel use and machine time such as work previously completed versus work completed that day

## DUAL/SINGLE GNSS SYSTEMS

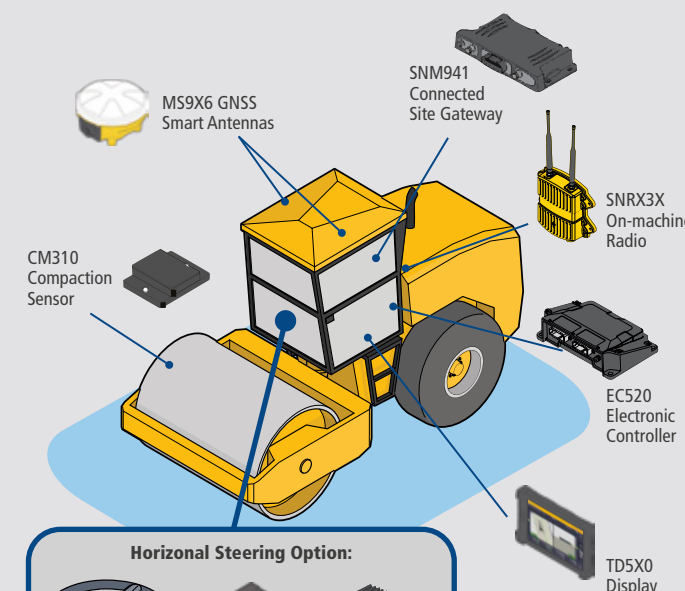

## UNIVERSAL TOTAL STATION SYSTEM

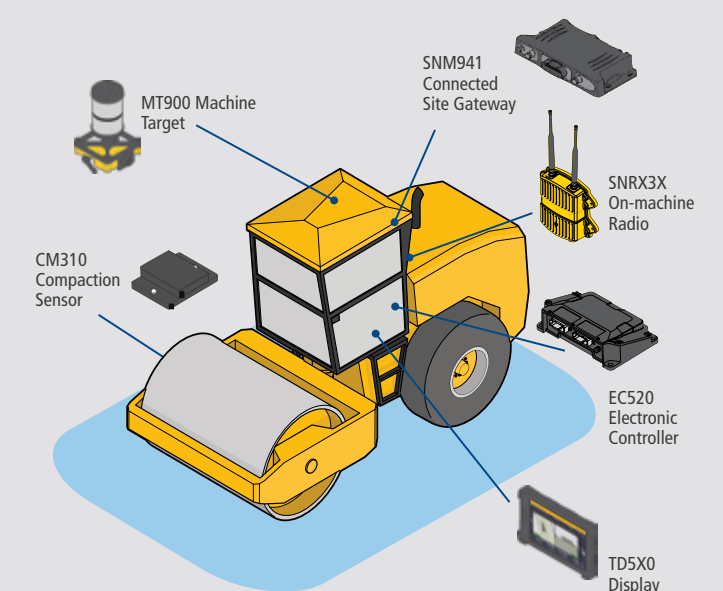

# TRIMBLE EARTHWORKS GO! 2.0

## 2D GRADE CONTROL SYSTEM FOR COMPACT GRADING ATTACHMENTS

Trimble Earthworks GO! 2.0 is the next generation of compact machine control, designed to enable system expandability and upgrades so your investment remains valuable and updated over time. Trimble Earthworks GO! 2.0 provides high-accuracy grading capability while reducing capital expense. This user installable, low-cost solution is the ideal first step into machine control for small contractors and owner operators. Compact, easy to use and highly portable, the system can quickly be moved from attachment-to-attachment for increased utilization and fast return on investment.

### SYSTEM FEATURES

- iOS and Android™ compatibility allows operators to use their smart device as the primary machine interface
- Trimble technology enables full sensing technology with no mounting hardware required
- Simple harnessing provides a low-profile, easy to maintain solution
- 2D automatic grade control
- Integrated installation and calibration tutorials that make setup easy
- Proven laser-guided technology enables high precision grading in less time
- Slope control with no laser to easily grade without any setup required
- Save machine profiles to enable one-time setup

### UNPARALLELED PORTABILITY

Trimble Earthworks GO! proprietary Trimble GO! 2.0 Box technology lets contractors quickly swap the system between machines to take care of the job at hand. Save machine profiles to the GO! 2.0 Box to ensure you only have to set up your machines once, so you can get back to work.

Ultra-portable and intuitive, Trimble Earthworks GO! provides high accuracy performance in all common grading applications such as pads, parking lots, sports fields, landscaping and more. It also works across the entire fleet of attachments for compact track and skid steer loaders.



# EASY-TO-USE, PORTABLE PLATFORM



### Smart Device User Interface

- Designed for visibility in bright daylight
- Intuitive software design for unmatched ease of use
- Integrated setup tutorials to get up and running faster than ever



### Trimble LR410 Laser Receivers

- 9 in (23 cm) detection window for maximum working range
- Can work with OEM masts or Trimble manual masts
- Perfect for high precision grading needs



### Trimble GO! 2.0 Boxes

- Fully portable with magnetic mounts
- Ruggedized for construction environments and exposure to the elements
- Trimble Comms Box contains a Bluetooth® communications device
- Trimble Sensor Box contains the system IMU



### DUAL LASER SYSTEM

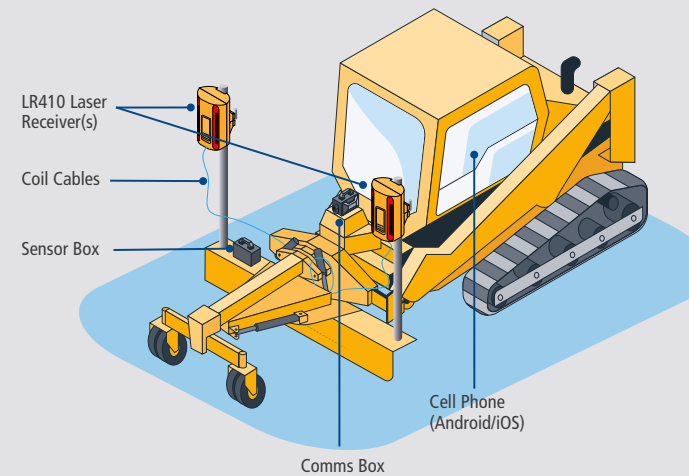

### SINGLE LASER SYSTEM

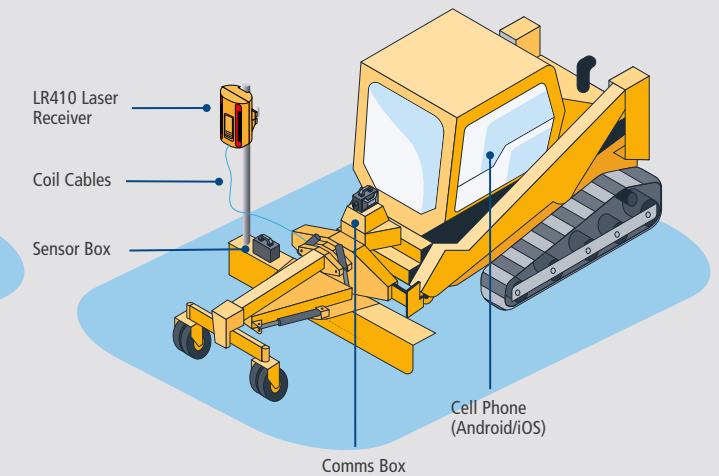

### CROSS SLOPE ONLY

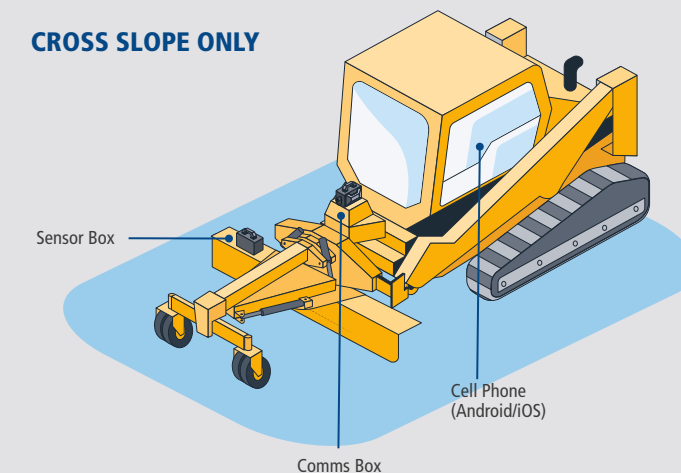

Trimble machine control systems are flexible enough to let you equip your entire fleet—excavators, dozers, scrapers, graders, trimmers, milling machines, compactors, pavers and more—with fully upgradeable technology. Start where you need to start and add as you need to add. Select the best option for the machine and application: sonic, angle sensors, laser, GNSS or total station.

### 2D ENTRY-LEVEL MACHINE CONTROL SYSTEMS

Trimble entry-level 2D machine control systems are ideal for smaller projects from initial site prep through to finished grading and paving, and leverage a range of fully portable components. All components are easy to move from machine-to-machine, easy to use, quick to set up and extremely durable to ensure the highest uptime and longest life possible in job site conditions. Additionally, these systems can be operated in manual or auto mode; in auto mode the blade is automatically moved to the correct position.

2D MACHINE CONTROL SYSTEMS

CONFIGURATION	TARGET MACHINES	DESCRIPTION	KEY COMPONENTS
<b>CROSS-SLOPE ONLY</b>	Dozers, Graders, Compact Grading Attachments	Cross-slope control system to be used on motor graders for fine grading work for road maintenance, ditches and slope work	2 angle sensors, Rotation sensor, Control box, SNM941
<b>SINGLE ELEVATION PLUS CROSS-SLOPE</b>	Dozers, Graders, Compact Grading Attachments	Single control system uses a laser or sonic receiver to control the lift of the machine blade and the cross-slope for flat, slope work, and finished grading	Laser, Laser receiver -or- Sonic tracer, Rotation sensor, 2 angle sensors, Control box, SNM941
<b>DUAL ELEVATION</b>	Dozers, Graders, Compact Grading Attachments	Dual control system that uses two laser or sonic receivers for higher accuracy lift control, blade edge can be controlled independently or linked	Laser, 2 Laser receivers -or- 2 Sonic Tracers, Control box SNM941
<b>DEPTH, SLOPE, AND ELEVATION CONTROL</b>	Excavators	Highly flexible system for excavation, trenching, grading and profile work	Angle sensors, Laser catcher, Control box, SNM941

### 3D MACHINE CONTROL SYSTEMS

Trimble machine control systems are the most versatile grading technologies available and can be used on a wide range of machine types including excavators, dozers, motor graders, compactors, milling machines, trimmers, pavers and more. By putting design surfaces, grades and alignments inside the cab, the system gives operators unprecedented control over grading, excavating, compaction and paving applications, significantly reducing material overages and dramatically improving productivity and profitability. The 3D systems can be operated in manual or auto mode and leverage a range of components that are fully portable and can be easily moved from machine to machine.

3D MACHINE CONTROL SYSTEMS

CONFIGURATION	TARGET MACHINES	DESCRIPTION	KEY COMPONENTS
<b>SINGLE GNSS</b>	Dozers, Graders, Scrapers, Excavators, Compact Grading Attachments	Measures the position and slope of the blade and compares that to design data for grading and mass excavation on complex design surfaces	Angle and rotation sensors, Single GNSS Smart Antenna, Control box, Rugged on-machine radio and SNM941
<b>DUAL GNSS</b>	Dozers, Graders, Scrapers, Excavators, Compact Grading Attachments	Measures the exact position, cross slope and heading of the blade, bucket, drum for rough grading and mass excavation on steep slopes and complex design surfaces	Dual GNSS Smart Antennas, Control box, Rugged on-machine radio and SNM941
<b>CAB-MOUNTED SINGLE GNSS</b>	Dozers, Wheel Loaders	Measures the position of the blade on the ground, comparing that to the 3D design for rough grading applications	Single GNSS Smart Antenna, Control box, Rugged on-machine radio and SNM941
<b>SINGLE OR DUAL GNSS WITH LASER AUGMENTATION</b>	Dozers, Graders	Single and dual GNSS systems enhanced with laser augmentation to improve vertical accuracy for high accuracy guidance to complex design surfaces such as super-elevation grading for rough through finished grade work	Single or dual GNSS Smart Antenna(s), Laser receiver, Control box, Rugged on-machine radio and SNM941
<b>UNIVERSAL TOTAL STATION</b>	Dozers, Graders, Excavators, Soil Compactors, Compact Grading Attachments	Total station-based system for high accuracy lift and layer control, material placement and monitoring, or for jobs where GNSS is not the ideal solution because of overhead obstructions	Single on-machine active target, Control box, Universal Total Station, Rugged on-machine radio and SNM941
<b>3D + SONIC</b>	Graders, Compact Grading Attachments	Uses 3D control on one blade tip and a sonic tracer on the other blade tip to match an existing structure, feature or the last machine pass	On-machine active target -or- GNSS Smart Antenna(s), Sonic tracer, Control box, Rugged on-machine radio and SNM941



Reliability is critical in paving work because the paving cannot stop. Trimble components are built to withstand the heat, steam, tamping and vibration that are regular on pavers, milling machines and compactors. And while system durability prevents downtime, Trimble's extensive distributor network ensures that training and support is always close.

## PAVING COMPONENTS TO STAND UP TO ANY JOB CONDITION



### TD510 and TD540 Displays

- Modern, colorful graphics
- Sunlight-readable, optically bonded LCD with capacitive multitouch interaction
- Android operating system for easy software extensibility
- Powerful octa core processor platform with dedicated graphics processor



### AS200 Angle Sensor

- One of the most accurate slope sensors in the business
- Produces slopes as tight as 0.1%



### CS200 Contact Sensor

- Mechanically traces a surface or a stringline



### ST220 Sonic Tracer

- The five sensors on the sonic tracer average out small irregularities on the surface
- Contact-free sensing of ground, curb or stringline
- More than 10 inches (25 centimeters) of sensing range when placed perpendicular to a stringline or narrow curb
- Maintenance-free ceramic sensors
- Automatic temperature compensation

## TRIMBLE BUSINESS CENTER SOFTWARE GOOD DESIGNS MAKE GOOD SURFACES

**Data preparation and management is easy with Trimble Business Center.**

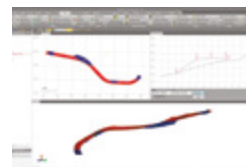

Using Trimble Business Center, you can create 3D design models and automatically generate uncompacted surface designs for the Trimble 3D Paving Control System.

The uncompacted surface designs guide the paver to automatically lay more material above low areas and less material in high areas, anticipating and eliminating longitudinal waves that can occur after asphalt compaction.

## TRIMBLE SPS930 UNIVERSAL TOTAL STATION

The Trimble SPS930 Universal Total Station controls the alignment of the machine and gives the system millimeter control over the screed. It works flawlessly in tunnels and overpasses, in tight corridors and over long distances. It also:

- Offers the best accuracy on the market— every millimeter saved reduces your milling and paving costs substantially
- It can very accurately drive the mill drum to cut to the 3D design within 0.01 - 0.02 feet (3-6 millimeters).
- Is flexible and reliable—you can work on sites where there is an obstructed view of the sky
- Has a 45 degree tracking angle—you can set it up very close to the mill in narrow corridors or in the drainage area between divided highways
- Transitions faster—Trimble Hot Swap technology transitions to the next total station without stopping the machine
- Maximizes your return on investment—other survey and machine control work can be done with the same instrument

## TRIMBLE HOT SWAP

Trimble Hot Swap technology makes total station transitions faster and less dependent on manual intervention from the operator. It automatically maintains the same tolerance between total stations, ensuring a smoother surface at the transition point and reducing the need to grind problem spots.

## 3D MILLING WITH TRIMBLE PCS900 PAVING CONTROL SYSTEM

Milling to a fixed depth often satisfies the specification for a resurfacing project, but it leaves any road smoothness improvements to the paver. With the Trimble PCS900 Paving Control System you can mill at variable depth and slope, eliminating undulations and preparing a smoother sub-surface for new asphalt. When used in conjunction with a paver equipped with Trimble Roadworks or PCS900, the end result is a significantly smoother road surface using less material and finished in less time.

## ACCURATE MILLING, NO STRINGLINES

Accurate milling begins with a quality 3D design model created in Trimble Business Center. The 3D design is displayed to the machine operator showing areas that are on, above, or below ideal grade. Comparing the actual drum position and slope with the digital design, the system automatically guides the milling drum to cut the ideal depth and slope without stringlines or manual adjustments.

With PCS900 on your mill, you can easily handle transitions, super-elevated curves, variable drainage slopes and longitudinal waves. And you can do it all without re-work.

## MILL SMARTER

Using PCS900 on your milling machine provides several benefits:

- Smoother base—mill out the existing undulations, creating a smoother surface for paving
- Shorter lane shutdowns—trucks can run more efficiently unhindered by stringline and stakes
- Reduced machine wear—by only milling to the depth required, the machine will burn less fuel and experience less teeth wear
- Less material to remove—fewer trucks and cost required to remove waste material
- Less asphalt usage—mill off the minimum depth and use less asphalt for the final surface

Result after fixed depth milling of a road with longitudinal waves

Result after 3D milling of a road with longitudinal waves

### PRISM:

Patented Trimble active tracking technology guarantees total station lock to the on-machine target and ensures millimeter control of the milling machine drum.

### TRIMBLE CB460 CONTROL BOX:

The Trimble CB460 Control Box indicates the position of the drum versus the 3D design or pre-defined vertical offset.



# TRIMBLE ROADWORKS

PAVING CONTROL PLATFORM

## 2D PAVING WITH TRIMBLE ROADWORKS PAVING CONTROL PLATFORM

The Trimble Roadworks 2D Paving Control Platform for asphalt pavers is ideal for projects that require meeting a thickness specification. When milling is done to design using Trimble 3D technology, Trimble 2D paving technology can easily handle the task of paving a fixed thickness.

Roadworks can reference off a surface, stringline or designed cross-slope. This makes the system an excellent, lower cost option for roads that have been graded or milled using Trimble PCS900 Paving Control Systems.

## MANY BENEFITS FROM ONE SYSTEM

Trimble Roadworks system can help you to:

- Lay the finished surface with accuracy to 0.01 feet (3 millimeters)
- Minimize use of expensive material, pave within a tighter tolerance and get closer to the minimal asphalt thickness specification
- Reduce labor costs by controlling the screed with one operator
- Eliminate operator mistakes with the easy-to-use display interface
- Achieve maximum smoothness and rideability
- Finish on time

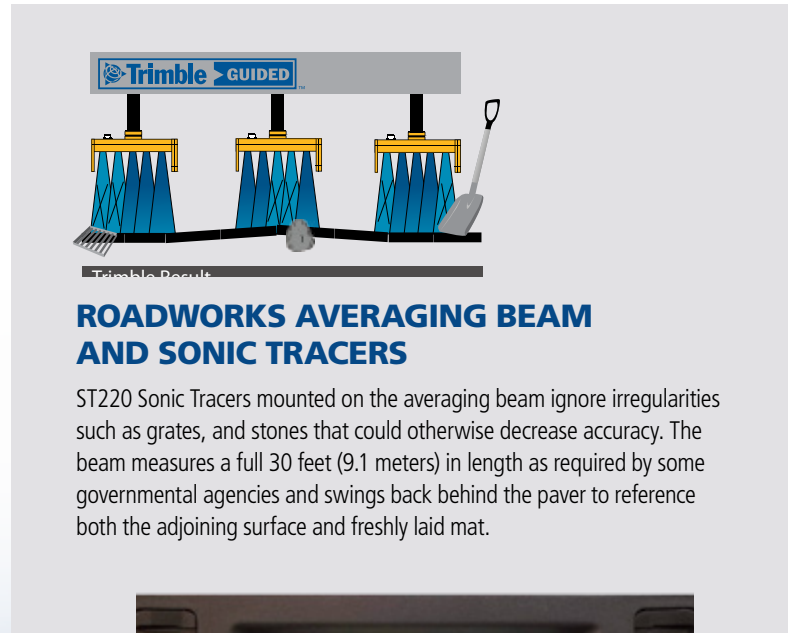

# FOR EXCELLENT RIDEABILITY RESULTS

3D ASPHALT PAVING

## 3D PAVING WITH TRIMBLE ROADWORKS PAVING CONTROL PLATFORM

The Trimble Roadworks 3D Paving Control Platform for asphalt pavers is a highly accurate, automatic 3D screed control system that can significantly improve paving productivity and rideability by directly referencing the design rather than a surface or stringline to minimize asphalt usage, reduce waste and overruns and finish projects on time and under budget.

When used with a traditional asphalt paving machine with a tractor and hydraulically controlled floating screed with a supported 2D system, Roadworks can be used to place any variety of materials, including hot asphalt, cold recycled asphalt, road base, gravel, concrete treated base, sand or any other paving material.

## PRECISION PAVING WITH LESS MATERIAL

The Roadworks system regularly achieves asphalt mat accuracies of 0.01-0.02 feet (3-6 millimeters), making it ideal for projects such as airports, large commercial surfaces and highways.

Accurate 3D control of the screed allows you to:

- Take out high and low areas early in the process with the less expensive materials
- Increase road smoothness using less asphalt than with traditional paving methods
- Lay complex designs such as transitions, super-elevated curves and frequently changing cross slopes
- Achieve accuracy and smoothness specifications, which can mean bonus income



The Horizontal Steering Control and automatic screed width controls on Vögele Navitronic asphalt pavers automatically steer and control the screed width for linear paving and radius paving according to 3D design, ensuring that pavement is placed accurately horizontally and vertically, all without operator intervention. Horizontal Steering and automatic screed width controls allow for a higher quality surface, and for more accurate, faster paving and with substantially less operator fatigue than with traditional asphalt paving methods.

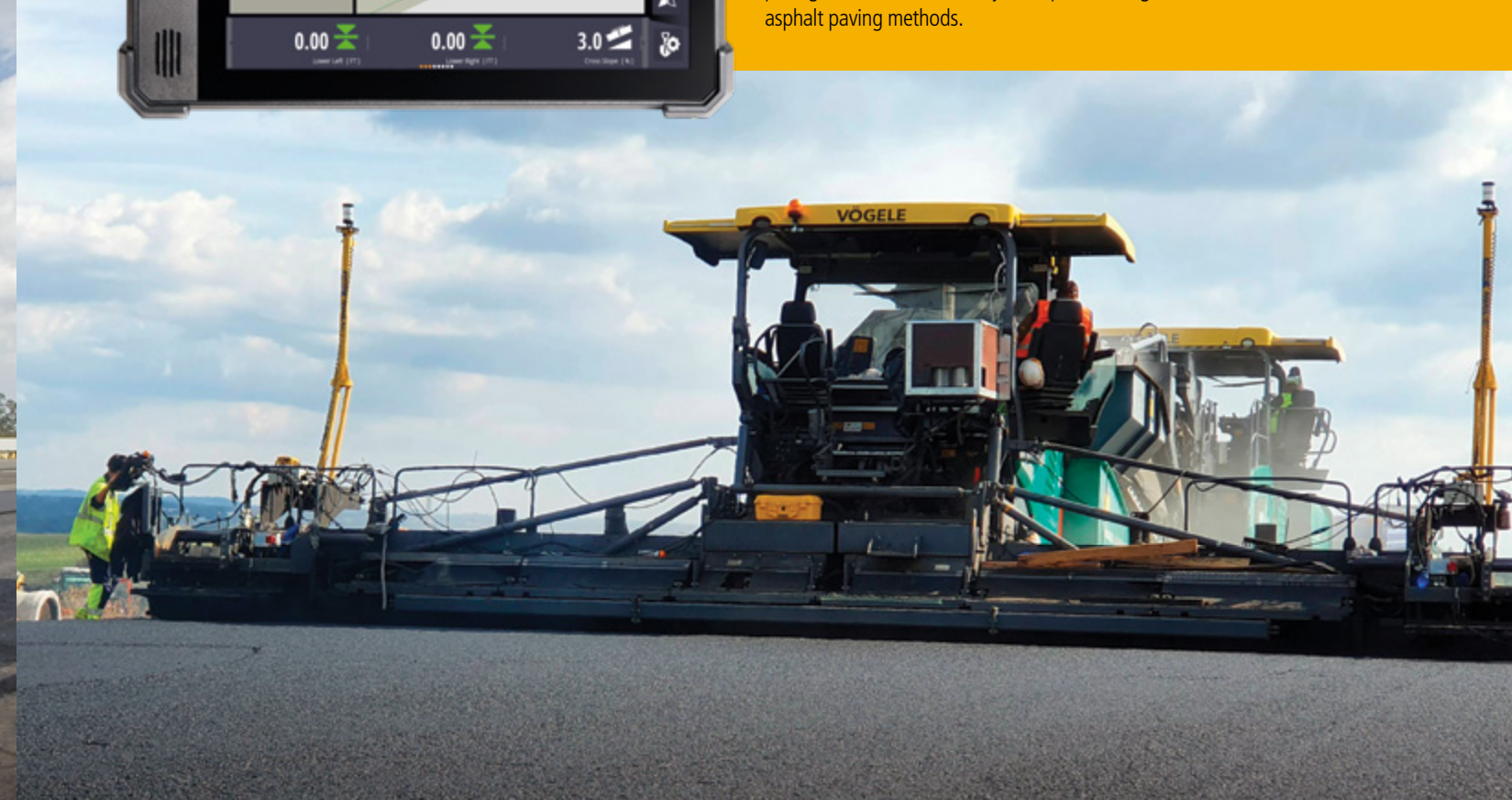

# TRIMBLE ROADWORKS

## PAVING CONTROL PLATFORM FOR ASPHALT COMPACTORS

Trimble Roadworks Paving Control Platform for Asphalt Compactors is the next generation Intelligent Asphalt Compaction (IC) system designed to help operators of all levels improve the speed, accuracy and ease of asphalt compaction.

The intuitive Android interface on a large, friendly touch screen enables you to easily view real time temperature mapping, compaction progress, pass counts and optional display and recording of the compacted asphalt density.

For asphalt and hot mix asphalt compaction applications, Trimble Roadworks is ideal for operations where the specification calls for a target density, pass count and asphalt temperature control such as highway and railway construction, residential pads, commercial site construction, parking lots and sports fields.

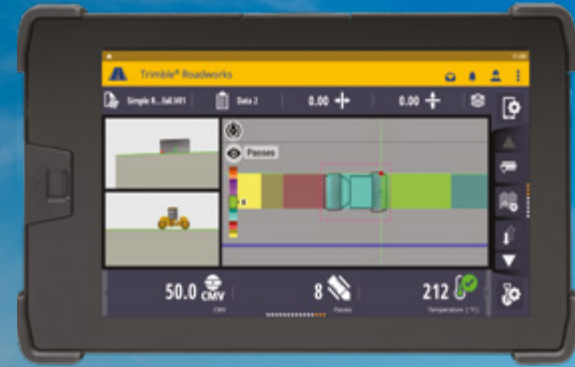

### INTELLIGENT COMPACTION

The asphalt compactor is the last machine to pass over your paving project, and mistakes during this phase can be very costly to fix.

Roadworks enables contractors to accurately control the compaction process, while reducing unnecessary passes that result in over compaction. The system achieves compaction target faster, more accurately and with less rework.

- Compact surface material to the desired compaction density and monitor site volumes simultaneously, in real time
- Ensure optimal compaction within the target temperature range, avoiding under and/or over compaction with real-time temperature map monitoring
- Achieve increased durability, stability and load-bearing capacity
- Easily meet Department of Transportation (DOT) or private job specifications



# FOR A PERFECT FINISH

### ACTIONABLE DATA

Supervisors and quality managers can monitor compaction activities in real-time, and operators can immediately identify the areas that require further compaction.

Office-only licenses offer extended functionality.

- Collect and document comprehensive, real-time compaction data to improve layer management
- Analyze data in the office to generate detailed reports and documentation to meet project specifications
- Continuously monitor pass counts and compaction measurement values (CMV) over the entire area to take corrective action as needed
- Improve testing success, reduce rework, operator hours and lower ongoing machine maintenance costs
- Reduce over-compaction to optimize fuel use and machine time

- Better understand work previously completed versus work completed that day
- Field data files can be directly imported into the Veta software platform to increase work opportunities and to gain a competitive advantage at the bidding process

### OFFICE-TO-FIELD CONNECTIVITY

Reduce waste and overruns with efficient communication and data transfer with Trimble WorksManager and Trimble WorksOS—mobile-friendly software that easily manages data and technology assets across job sites.

With the Trimble SNM941 Connected Site Gateway, transfer 3D designs from the office to the machine wirelessly and automatically so that the operator is always using the latest design. Productivity data collected from the machine can automatically sync back to the office.

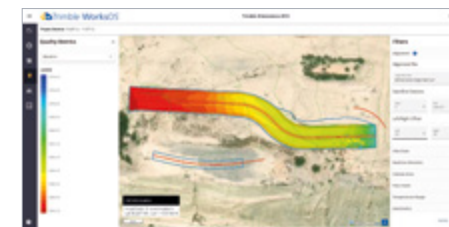

Trimble WorksOS Software



Trimble WorksManager Software

### SINGLE GNSS SYSTEM

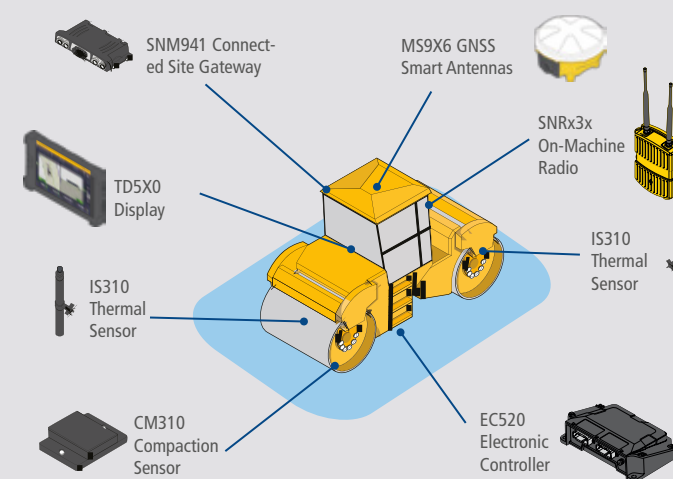

### UNIVERSAL TOTAL STATION SYSTEM

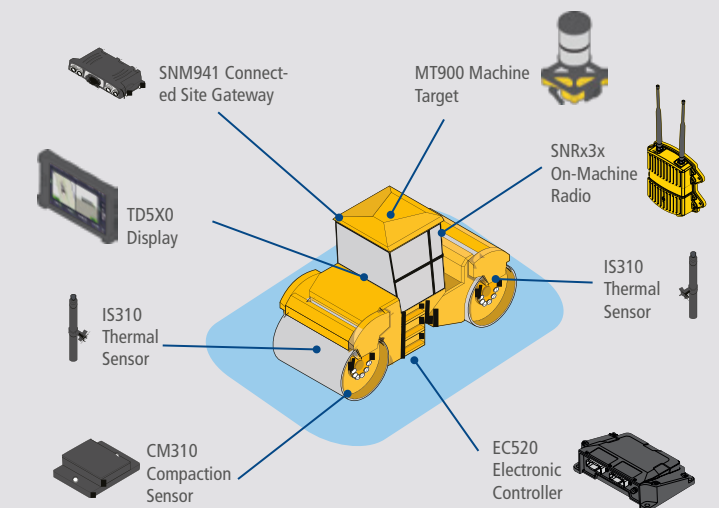

# TRIMBLE ROADING SOLUTIONS

## 3D SLIPFORM PAVING

### NO STRING, NO DELAYS

It's time to kick stringline off your site...

Stringline delays your pour, it costs too much, and it's just too hard for your haul trucks to drive around. Every time it breaks, you have to stop the machine. Every time it sags, your surface suffers and so does your bonus.

Once you start paving with the Trimble PCS900 Paving Control System, you'll wonder how you could ever use string in the first place. You'll start working faster every day. Your haul trucks can pull up and dump without driving around string. You'll stop less often, grind fewer problem spots and blow away your target IRI number.

# CONCRETE PAVER GUIDANCE

## STRINGLESS AND PRECISE

### MORE CONTROL, LESS WASTE

Trimble PCS900 Paving Control System for Slipform Pavers uses automatic steering and 6-way control of the pan to keep the paver exactly on the target alignment, grade and slope. The result is a more consistent concrete surface with better rideability and a bigger bonus – without the time and cost of string.

You'll see efficiency improvements through:

- Improved site logistics and safety
- On time delivery of mix
- Better yield
- Increased smoothness

### ONE INTEGRATED WORKFLOW

The cost of concrete rework is too high to be working with multiple manufacturers and file formats. Using one integrated workflow from Trimble, you can be confident of the quality of your work, and stake your reputation on the results.

Pave to the 3D design, and your grade checker can work from the screed using a Trimble rover, the same 3D design model and total stations to verify the as-poured surface.

Plus, training and support from your local SITECH Technology Distributor means you are never working alone.

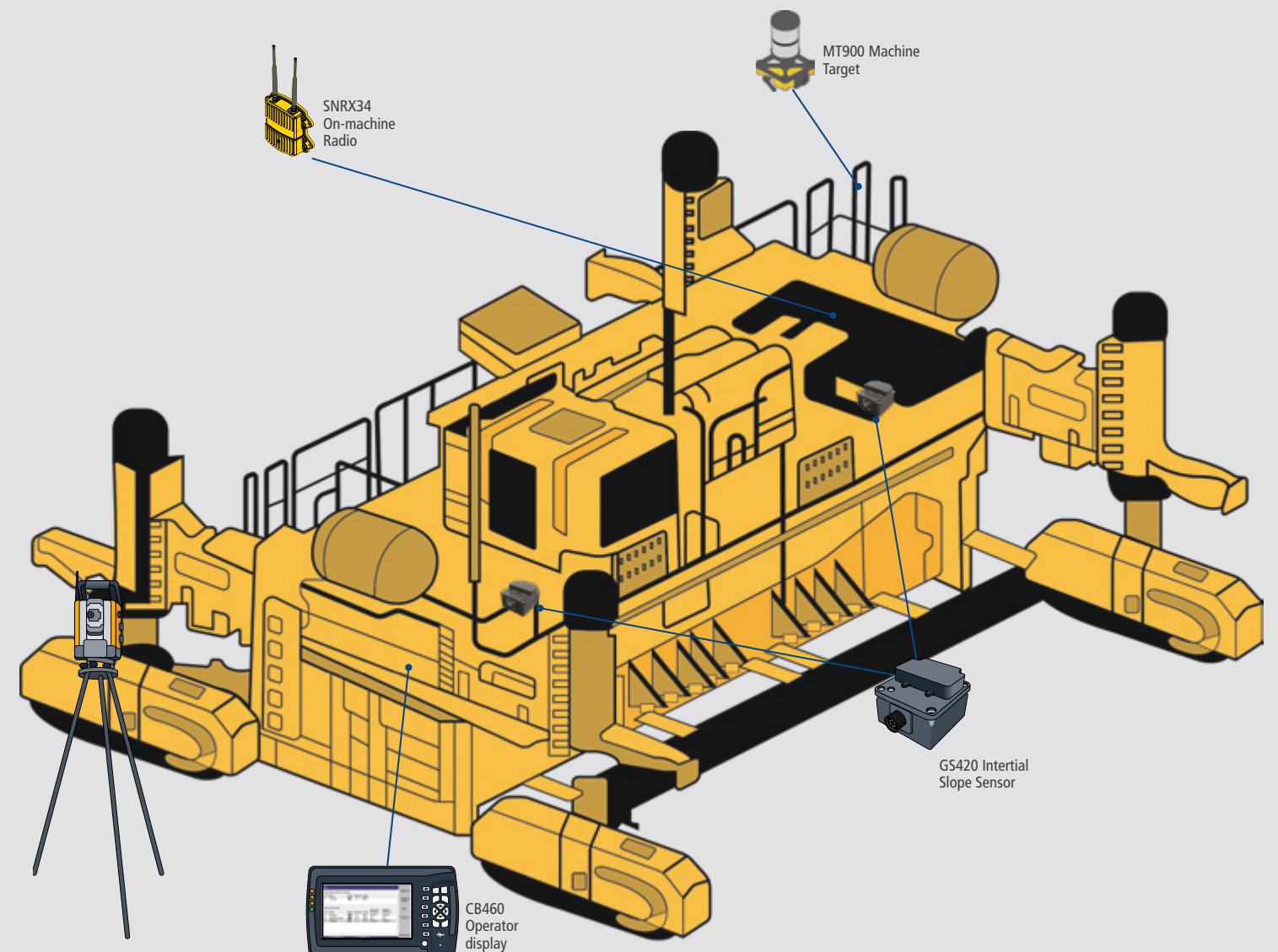

# TRIMBLE GROUNDWORKS

MACHINE CONTROL SYSTEM FOR DRILLING, PILING AND COMPACTION

Trimble Groundworks Machine Control System can enhance on-site safety, accuracy and the efficiency of your drilling and piling operations. All day, every day, in any weather.

Realize maximum production and revenue with the Trimble Groundworks Machine Control System—an aftermarket, land-based, 3D drilling and piling system for the mixed fleet operator.

- Stakeless drilling or piling and minimal lay out reduces workload and cost
- Keep personnel safe by reducing the need to be near machines and warns the operator when entering avoidance zones
- Limit operator fatigue by reducing paperwork

## BENEFITS:

- Stakeless navigation and minimal lay out reduces workload, rework and errors
- Improve site safety by reducing personnel near machines and using avoidance zone alerts
- Auto Stop drills only to the defined elevation
- 2D workflow keep you working even during GNSS signal loss
- In-field drill plan and quality/production reports
- Very high accuracy and precision using RTK positioning
- Navigate to inclined or vertical holes from any direction
- Logging as-built data during operation

## APPLICATIONS

- Drilling
- Piling
- Solar farm construction
- Blast hole drilling
- Structural piling
- Wick drain installation
- Continuous flight augering (CFA)/ auger cast piling
- Anchor/monopile drilling
- Dynamic compaction

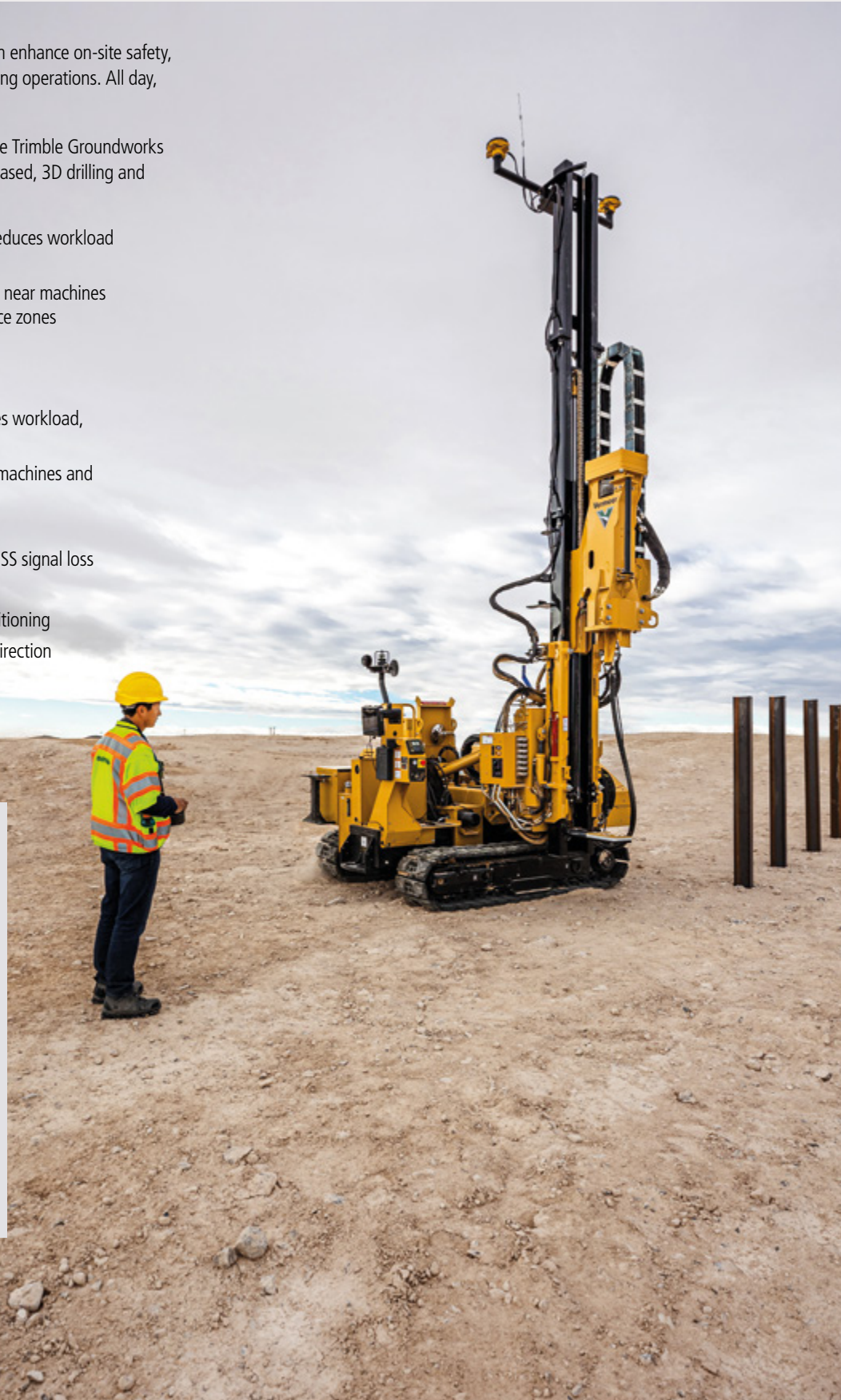

# OPTIMIZE PRODUCTION AND REVENUE

## TRIMBLE VERSO 12 DISPLAY

### Keep your machines working. Not waiting

Your machines can be up and running 24/7 with the rugged and fully connected Trimble VERSO 12 and Trimble Groundworks. The easy-to-read touchscreen makes navigation simple and quick.

- Rugged VERSO 12 display
- Clearly see avoidance zones for safer sites
- Configurable views
- Easy-to-use, intuitive interface
- Modern colorful graphics



Part of the Trimble Connected Site portfolio, Groundworks is an integrated solution that brings the office and the field together to give you less rework, more productivity, and best of all—more profitability.

- Trimble Business Center creates and manages design data to avoid costly mistakes
- Connected Community allows design data to be shared in the cloud and ensures operators are always working with the most recent information
- Groundworks gathers as-built data so Trimble Business Center can run accurate quality, production, and utilization reports

Trimble WorksManager Software makes it easy to manage up-to-date connected design data and track all of your fleet assets across multiple project sites.

## TRIMBLE BUSINESS CENTER

### Optimized drill plans. Optimal results

Rapidly create optimized 3D drill or pile plans with Trimble Business Center software, then generate comprehensive quality and production reports. With Trimble Business Center and Trimble Groundworks, more profits are at your fingertips.

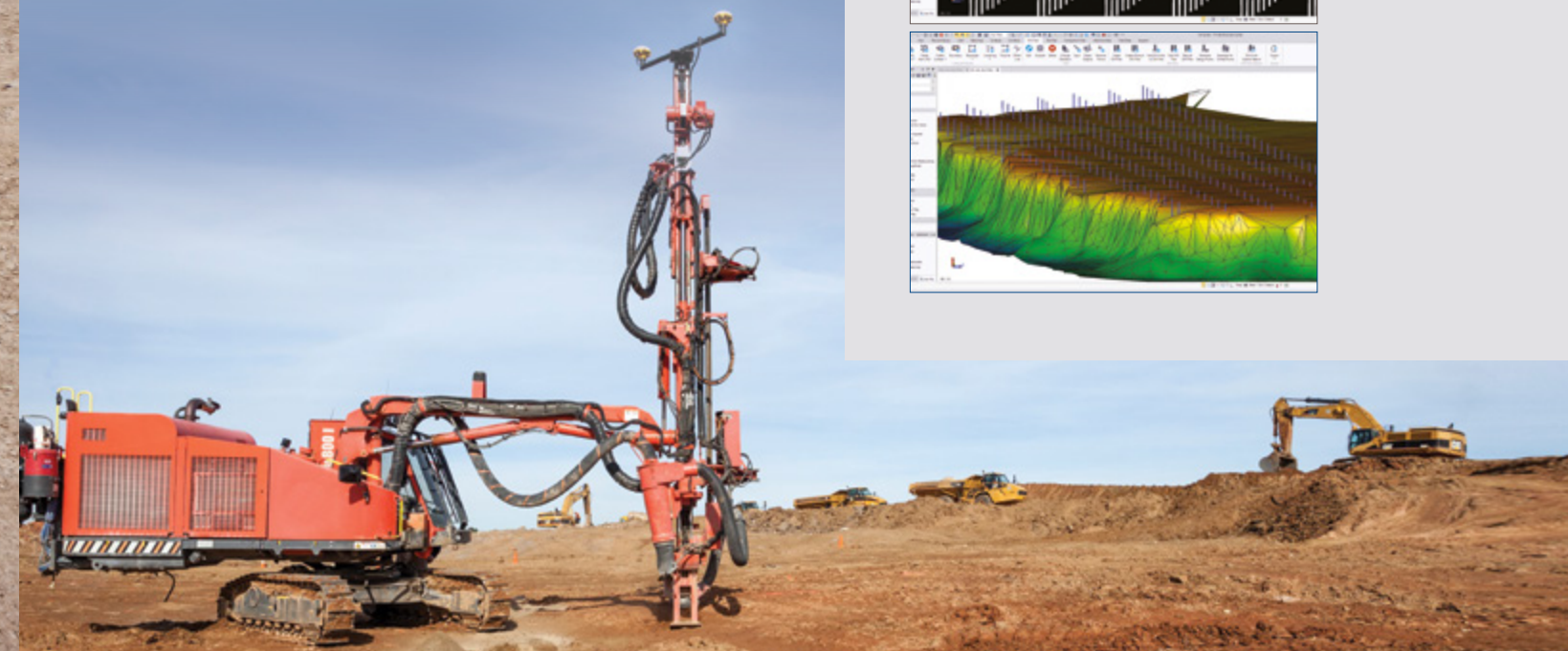
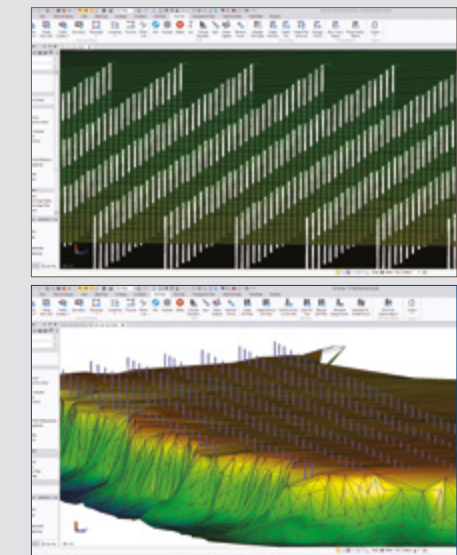



# CONNECT YOUR JOBSITE

WITH THE TRIMBLE JOBSITE CONNECTIVITY BUNDLE

A single source of truth for constructible data in the field and office helps you avoid time-consuming rework, share data seamlessly across a project, and know everyone is on the same page.

With the Trimble Jobsite Connectivity Bundle, management and collaboration software tools seamlessly work together to create a more powerful and more cost effective solution. If you already have Trimble software solutions, an upgrade to get the benefits from the synergy of the connectivity is now possible, delivering more value at a more cost effective price.

The bundled Trimble software solutions enable full visibility of what is happening on site and confidence that everyone is working to the latest plan. This gives contractors peace of mind in an industry where projects are complex and constantly changing.

# PROJECTS AND DATA

CONNECTED FROM OFFICE-TO-FIELD



## TRIMBLE CONNECT

Trimble Connect® is a cloud-based collaboration platform where project stakeholders can share, review, coordinate and comment on construction models, schedules and other project information.



## TRIMBLE BUSINESS CENTER

Takeoff and modeling software that can be used to calculate earthwork and material quantities for bids, build constructible 3D models for construction surveying and machine control, and more.



## TRIMBLE WORKMANAGER SOFTWARE

A cloud-based application that remotely sends construction-ready models to machines and construction surveyors in the field, so operators are always working in the latest designs.



## TRIMBLE WORKSOS SOFTWARE

Integrates design data from the office with machine control as-built data to provide real-time jobsite progress and productivity updates.

## SIMPLIFIED PRE-CONSTRUCTION

Connecting construction operations can pay off even before the project begins. Accurate information at your fingertips allows for better planning, scheduling and bidding.

- Quickly and easily confirm designs without expert-level skills
- Avoid time-consuming file formatting and opportunities for error

## COMPATIBLE WITH A WIDE RANGE OF SOLUTIONS

- Connect all stages of the construction project
- Standardized data allows for wider use across the project
- Support for third-party solutions increases business opportunities
- Transfer files between different field systems operating on the same site
- Leverage the Trimble Connect Software Developer Kit (SDK) to integrate third-party tools with Trimble civil construction software
- Supports LandXML based data exchange

## AVOID REWORK

Quickly modify plans and coordinate with field operations from anywhere in the world, avoiding costly mistakes from an outdated design or incorrect coordinate system.

- More efficient and faster file transferring to reduce risks of mistakes
- Cleaner handoffs from engineers makes sure everyone is working from the same design with less effort
- Provide transparency across entire organization so you're always looking at the latest information
- Settings flow throughout projects, and projects flow throughout systems



# TRIMBLE WORKSOS

REAL-TIME PRODUCTIVITY DATA FROM YOUR JOB SITES

Trimble WorksOS Software is a cloud-based solution delivering 3D productivity and real-time progress for site supervisors and project managers to plan and maximize job site efficiency. WorksOS enables multi-user collaboration and communication, giving stakeholders immediate access to the latest information, workflows and project status to empower decision making. The software performs real-time calculations efficiently and consistently to make it easier to understand real work progress and pro-actively make adjustments to stay on budget and on schedule.



# FLEXIBLE TECHNOLOGY SOLUTION

TO FIT YOUR BUSINESS

## BENEFITS

- View the progress to plan for each project in a single dashboard
- Real-time cut, fill, volume, and compaction data for increased visibility of machine and job site productivity
- Drive your machine activity from a central site design for real-time progress versus plan updates from the field
- Effortlessly track the progress of multiple working zones and activities for validation of work performed
- Remote access saves time on unnecessary job site visits, frequent check ins and surveys

## KEY FEATURES

### Connected Construction

- Upload designs, topographical and drone surveyed surfaces, and machine as-built data
- Integrated designs from Trimble Business Center
- Interoperability with Trimble Connect and Trimble WorksManager Software for project, design and asset management
- Utilize machine productivity data from Trimble machine control systems

### 3D Productivity Monitoring

- Real-time cut, fill, volume and compaction data
- Adjust daily work targets to stay on schedule
- Visibility into which machine is working
- 2D cut/fill maps for material movement
- Pass count maps for compaction
- Filtering capabilities based on machines, geofences and lifts
- Progressive volume charts to show cumulative total over time

### Activity Workflow Advantage

- Define the start/end, quantity and design targets of an activity
- Track progress and productivity to optimize bidding, scheduling and estimating
- Intuitive interface enables users to easily monitor job site metrics without having to understand and setup complex filter settings
- Key metrics and completion status of activities in a summary report dashboard for convenient monitoring and reporting
- Identify when progress is behind schedule to make resource corrections and get back on track

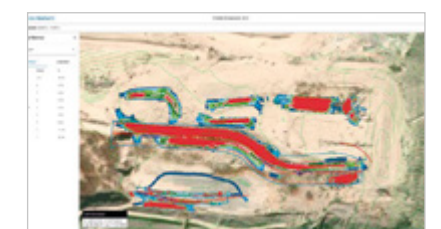
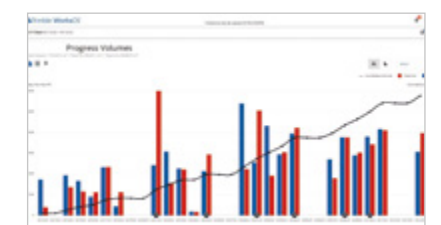
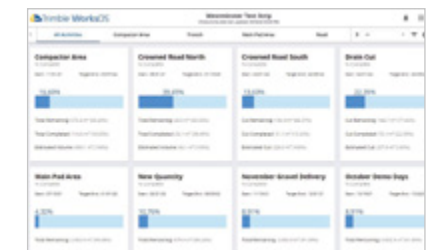

# TRIMBLE WORKSMANAGER

NOW YOU CAN BE EVERYWHERE AT ONCE

Trimble WorksManager Software allows users to wirelessly transfer data such as 3D designs to the construction site, increasing efficiency and saving drive time and money. Supervisors and data managers will be sure that the right machines or data collectors are always using the current design.

A practical dashboard shows managers an overview of their sites. Contractors can prevent costly mistakes and rework by seeing their construction technology in the field in real time.



# EASILY MANAGE YOUR DATA AND ASSETS

WITHOUT LEAVING THE OFFICE

WorksManager seamlessly connects the office and the site to improve a variety of workflows. For example:

- WorksManager enables foremen to supervise and coordinate multiple crews and multiple projects from one location
- Site supervisors can trust that the correct design is being used in the field
- WorksManager gives data prep professionals the confidence that their changes are being communicated and applied at the site
- WorksManager can extend the range of existing base station corrections so GPS and survey managers can send crews out over a larger area

## ALWAYS CONNECTED AND UP TO DATE

- Easy-to-use workflows keep current information at your fingertips
- Mobile friendly, data is available when and where you need it
- Integrates with Trimble Earthworks, Trimble Siteworks Positioning System and Trimble Business Center
- Up-to-the-minute, actionable data empowers you to run your business more confidently and profitably
- Limit the risk of miscommunication to and from the field with automatic data transferring

## SEAMLESS TRANSFER

- Easily transfer data to and from devices over the internet
- Stream corrections to your devices

## JOB SITE VISIBILITY

- Keep track of the location of your devices and machines with detailed activity information
- Intuitive dashboard shows an at-a-glance view of your digital assets and design information wherever you are
- Monitor operations to keep the job on track and keep costs down

## REMOTE ASSISTANCE

- Troubleshoot issues in the field from the office
- Efficiently support the team in the field from wherever you are, react quickly when things go wrong and get everyone back to work faster

Modern, colorful graphics

Android and iOS compatibility

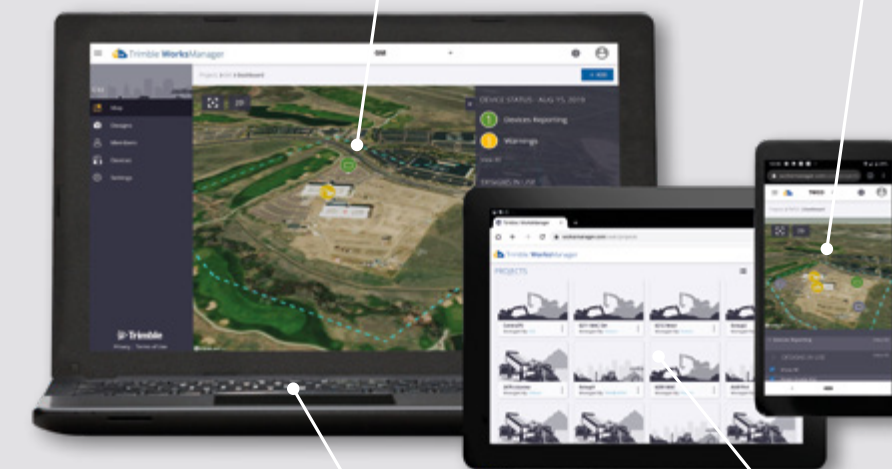

Over the air data transfer and field communication

Configurable views

# TRIMBLE BUSINESS CENTER

INCREASE EFFICIENCY IN THE OFFICE AND ON THE JOB SITE

# FOR YOUR PROJECTS

FROM START TO THE END

## OUT-BID AND OUT-PERFORM

Trimble Business Center is your complete office software solution to out-bid and out-perform your competition. Manage data and accomplish tasks throughout the project lifecycle for civil construction job sites, highways and marine applications in a single software package. Make better decisions, decrease costly mistakes, and increase efficiency in the office and on the job site.

With Trimble Business Center you can efficiently calculate earthwork and material quantities for bids, prepare data for construction stakeout, build 3D models to optimize machine operation, track productivity and understand how profitable you are on any given project.

## FROM BID TO BUILD

Win more bids by preparing 3D earthwork and construction takeoffs quickly and accurately with enhanced levels of detail. Use Trimble Business Center's CAD tools, surface to surface comparisons and material management to accurately estimate projects and take full control over data throughout the project lifecycle.

Easily prepare data for field devices and seamlessly manage the data flow between the office and the field. Reduce rework by ensuring data is clean, up-to-date and delivered in the right format to get the job done. Deliver the highest quality results which can be displayed in a variety of reports and models.

## CONNECT MORE DATA

Leverage the power of survey and construction data in a single, robust software environment to confidently deliver project after project with Trimble Business Center. Connect more data without the hassle of switching between software platforms, lowering operational costs and increasing productivity. Combine raw measurements from GNSS, total stations, and levels — then, add in data from unmanned aerial vehicles (UAVs), mobile mapping systems, and terrestrial laser scanners — all of which is scaled to your survey data. No need to import and export between multiple software packages. No need for training, renewals, or support for different applications from different providers.

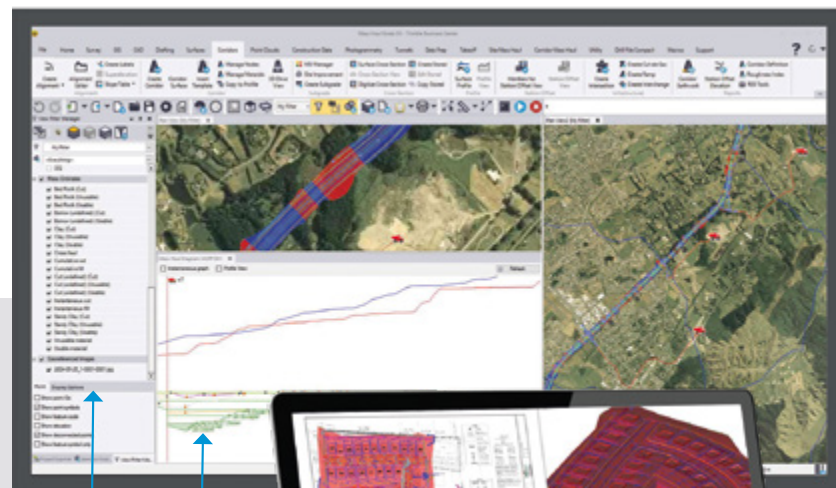

Prepare takeoffs with confidence

Seamlessly manage data between the office and the field



Manage data over the entire project lifecycle

Write your own commands to customize with Macros

One software for all your construction and survey needs

Quickly and easily create, edit and report information

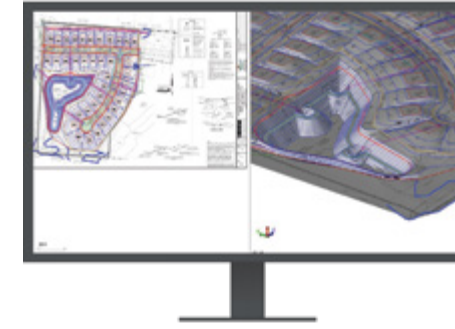

Digitize plan sets from PDF into 3D linework and models

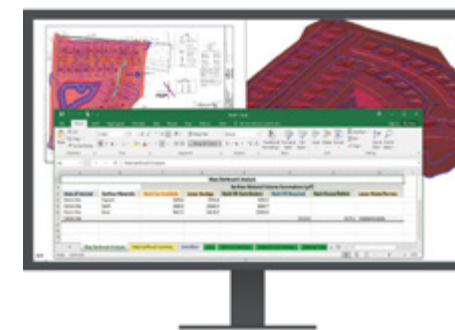

Calculate earthwork, material and cost data

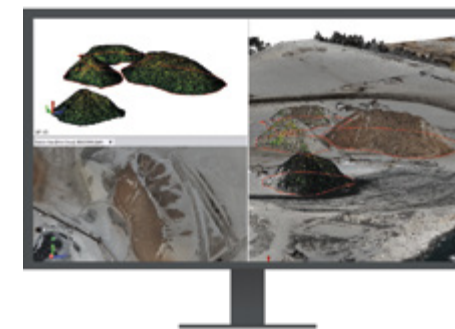

Compute precise surfaces and volume stockpile quantities

## SUPPORTED WORKFLOWS

### Data prep

Make sure your data is clean, up-to-date, and delivered in the right format to get the job done. With Trimble Business Center you can easily organize all your data and digitize plans into 3D models, saving time and allowing you to focus on getting the job done.

### Takeoff and mass haul

Calculate earthwork and material quantities of a construction project and generate takeoff mass haul reports. Optimize site and corridor earthworks to increase profits.

### Surfaces and volumes

Create, process, and deliver complex surface models for field devices, machine control systems, and third-party export. Generate quick and accurate volume reports from surface comparisons, stockpile/depression, and corridor surfaces to quantify progress on your projects and see how much work is left to do.

### Alignments and corridors

Model and manipulate alignments and parametrically-designed corridors. Handle complex roadway projects, design corridor features and generate reports in minutes.

### CAD and drafting

CAD tools to produce your final survey linework, construction models, and roadway design plots with ease.

### Aerial photogrammetry

Fly virtually any UAV to obtain data that you can adjust, measure and model. Simply drag and drop your drone data to import and then create industry leading, highly accurate deliverables in an easy-to-use three step workflow.

### Scanning and point clouds

View, manipulate, and extract information from terrestrial, mobile, and aerial point cloud data.

### Utility modeling

Create pipe and utility networks for takeoff and visualization applications.

### Drilling, piling and dynamic compaction

Prepare work plans and reports for boring and drilling, foundation and infrastructure piling, dynamic compaction and connect to the Trimble Groundworks Machine Control System.

## FUTURE-PROOF SUBSCRIPTION

Get all the latest features with regular updates for civil construction customers. Trimble Business Center works seamlessly with Trimble Siteworks Software, Trimble SCS900 Site Controller Software, Trimble Earthworks Grade Control Platform, Trimble GCS900 Grade Control System, Trimble PCS900 Paving Control System, Trimble CCS900 Compaction Control System, Cat® AccuGrade™ and Cat GRADE Grade Control Systems.

# TRIMBLE STRATUS

## DRONE DATA PLATFORM FOR CONSTRUCTION

Trimble Stratus Software helps civil contractors use drones to map, measure and share accurate information about their worksites and assets. With Stratus, you can make quicker decisions, avoid mistakes, and grow profits by always having the right information on hand.

### CONFIDENTLY PLAN AND ESTIMATE

Know what you're quoting: Conduct your own site surveys before the job begins, and whenever changes occur.

### SURVEY FREQUENTLY AND FASTER

Get accurate, up-to-date topographic surveys whenever you need.

### COMMUNICATE EFFECTIVELY

A visual timeline keeps everyone on the same page. Track site changes, avoid crossed wires, and resolve disputes quickly.

### TAKE CONTROL

Save money and avoid information bottlenecks. Get answers to questions yourself with an intuitive, web-based tool.

### HOW IT WORKS

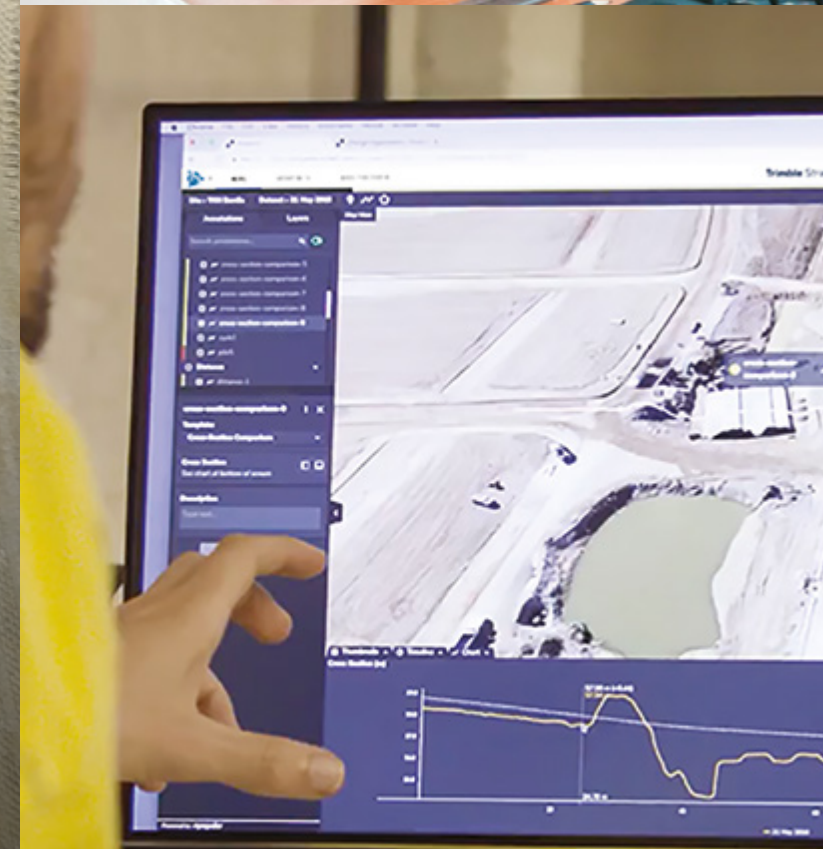
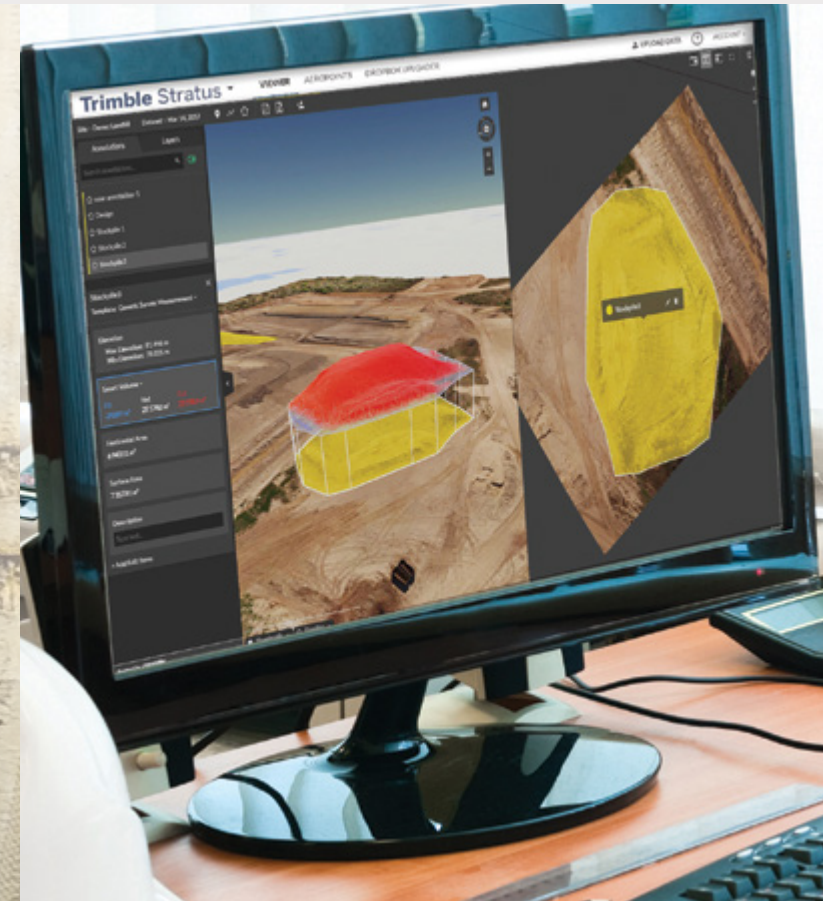

# DRONE DATA ANALYTICS

### SITE VOLUMES

- Calculate overall material volumes added or removed from pits, stockpiles, cells, drainage channels, etc.

### DESIGN CHECKS

- Upload design file to compare actual surface to design surface and track progress
- Easily measure distances, slopes and heights to compare with site measurements

### SUBCONTRACTOR MANAGEMENT

- Perform quick volume calculations of material moved for progress payments
- See proof of site changes via a visual timeline
- Fewer disputes as your portal can be shared with subcontractors so everyone is on the same page

### ROAD AND TRAFFIC MANAGEMENT

- Measure road grades, cross-slopes, road widths and windrow heights with one click. Optimize traffic plans with a complete, up-to-date site map, and easily direct personnel to where they need to be
- Reduce cycle times and optimize mobile plant efficiency by tracking haul road design conformance

### SAFETY

- Reduce people-to-machine interactions by surveying inaccessible or hazardous areas safely using a drone
- Get overall site images for inspection works, without sending personnel on-site
- Track changes in slope angles to better manage slips

### ENVIRONMENTAL RESPONSIBILITIES

- Get frequent, detailed images of site boundaries and protected areas to easily demonstrate your conformance with regulatory requirement

### PROJECT EFFICIENCY

- Integrates with Trimble Business Center and Trimble Site Positioning Systems for consistent local coordinate definition
- Conduct your own site surveys for more accurate estimates
- Tighter plans and budgets as a result of more frequent and accurate volume data
- Fewer site visits needed when people can track progress and inspect work remotely
- No more information silos or unnecessary hold-ups when everyone can work from the same current survey data

# TRIMBLE SITEVISION

AUGMENT YOUR REALITY

Trimble SiteVision™ software is a user-friendly augmented reality system that brings your data to life in real-world environments so that cut/fill maps, pass count maps, density and more become visible, right from your mobile device.

## INCREASE EFFICIENCY, DECREASE RISK

The intersection of physical and digital worlds in SiteVision allows contractors to bring data to life. Providing real-world context to designs enables users to quickly communicate complicated plans and drawings, confirm designs and precisely identify where hidden assets are to minimize costly errors and safety related incidents. Easily understanding progress on site keeps everything on track and reduces the possibility of unexpected issues along the way.

## KEY FEATURES

- Accurately places and displays 2D/3D data in real-world context from any angle at true-to-life scale
- Precisely locates and reveals hidden assets
- Automatically transforms complex 2D designs into visual 3D models
- Switches between 2D and 3D views
- Provides Trimble cloud-based data hosting and reporting tools
- Enables collaboration and communication of designs on the job site
- Seamlessly integrates with your data from Trimble Business Center, SketchUp, Trimble Novapoint, AutoCAD and more
- Lightweight, portable handheld or pole-mounted unit

# BRING YOUR DATA TO LIFE



## APPLICATIONS

- SiteVision enables users to easily understand new designs, existing underground services, and how future landscapes will look over time without the need to interpret complex 2D plans.
- Plan and visualize on site progress, inspect completed work, complete quality management and identify issues early to reduce costs and time
- Check finished grade and laid material thickness against design elevations and tolerances
- Confirm designs and avoid issues by identifying the location of utilities in the context of the real-world
- Monitor and conduct quality control for earthworks and paving operations
- Synchronize design and field data
- Share, communicate and collectively interact in real time with easy-to-understand visualizations for efficient collaboration with people of all skill levels
- Improve communications between the field and office by connecting more people on and off the job site
- Take photos, measurements and notes in the field for accurate and up-to-date reporting, create tasks and assign them to team members
- Use sub surface mapping information to improve plans by visualizing the location, size and attributes of underground infrastructure such as water, power, gas and telecommunications

# TRIMBLE SITEWORKS SOFTWARE

FOR CONSTRUCTION SURVEYORS AND SUPERVISORS

Trimble Siteworks Software is an easy-to-use field software that enables grade checkers, site engineers, site surveyors, supervisors and foremen to do their jobs more efficiently by taking the constructible model into the field. From initial site reconnaissance to finished as-built collection, Siteworks offers an efficient way to collect and distribute site measurements, perform stake out tasks, manage multiple work orders and job sites, monitor progress, and report the results.

## SUBSCRIBE NOW

Now available in a subscription model with flexible terms to modernise your equipment with no large upfront cost.



# MADE FOR THE WAY YOU WORK

## A COMPREHENSIVE SOLUTION FOR CONSTRUCTION SURVEYING, WITH OPTIONS BASED ON THE TOOLS THAT YOU NEED.



**Roading Module Siteworks** supports road and highway projects by incorporating full alignment geometry, station equations, width transitions and multiple roadways within a selected road job. The Roading Module provides a single solution to all road staking needs—from roadway features to catch points to custom subgrades. In addition, the grade checking functions allow contractors to easily perform as-built checks and quality control.



**Advanced Measurement Module** improve “field to finish” as-built workflows with time-saving features such as point and line offsets, line closure, curved line measurement and continuing existing lines. The Advanced Measurement Module enhances Siteworks functionality with streaming data outputs, total station traverse measurements, and the ability to connect to utility locators. Improve informed decision-making by capturing additional information with each measured point; photos, dimensions, conditions and material type add valuable information about a feature in addition to its position.



**Siteworks SE Starter Edition Software** is a simplified version of Siteworks, intended for users who do not require a full feature set and are interested in a lower-cost version to connect to GNSS only. Similar to the standard version, Siteworks SE supports PDF reporting, tilt compensation and vehicle mode measurements. Featuring full compatibility, seamlessly upgrade to Siteworks as soon as your needs expand.

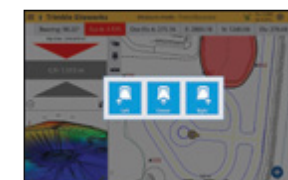

**Siteworks Machine Guidance Module** enables contractors to perform a variety of tasks on the job site both on and off machines. Trimble SPS986 or Trimble R780 GNSS Smart Antenna with tilt compensation, a machine kit and any data collector that supports Trimble Siteworks is all the hardware you need. Use it first as a rover to measure up projects and create in-field designs, then hook it up to your machine to carry out the work—building exactly to design. Go from grade checking and layout to machine operation and back again, moving between sites and machines for a system that is always fully utilized.

## TRIMBLE SITEWORKS: MACHINE GUIDANCE MODULE

Trimble GNSS Smart Antenna with tilt compensation

Trimble Data Collector

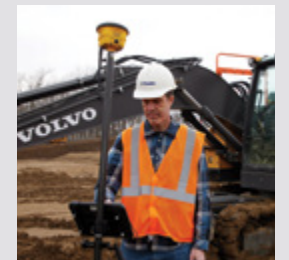
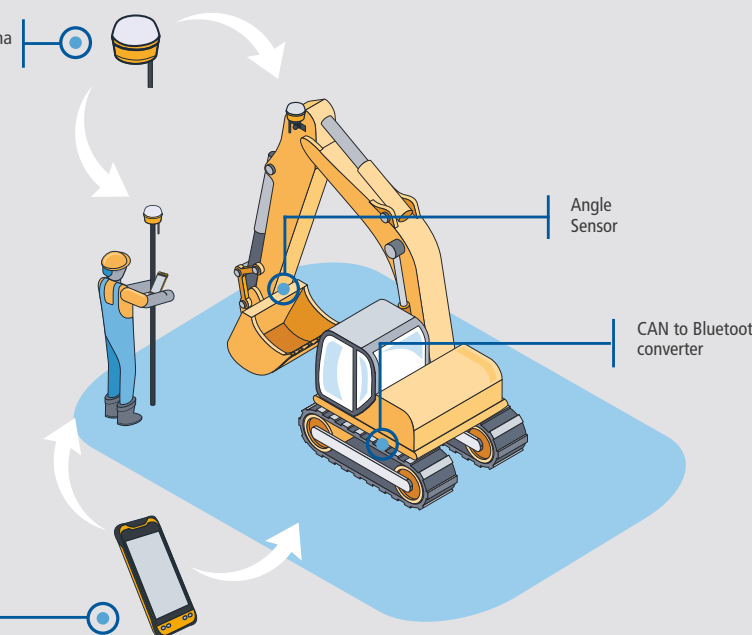

# TRIMBLE SITEWORKS SYSTEMS

FOR CONSTRUCTION SURVEYORS AND SUPERVISORS

# CHOOSE THE CONTROLLER

THAT BEST FITS YOUR NEEDS

The fully integrated Trimble Siteworks Positioning Systems are designed to eliminate downtime by making every minute more productive. With increased processing power and Microsoft® Windows 10, the systems enable quicker handling of complex files and 3D data sets, — meaning you can spot issues and solve problems before they slow you down.

## SITWORKS POSITIONING SYSTEMS

### For Surveyors

The **Trimble Siteworks Positioning System for Construction Surveyors** includes Siteworks Software, the R780 or SPS785 GNSS Smart Antenna and either the TDC600 Handheld, T7 Tablet, TSC5 or TSC7 Controller.

#### Key Features

- Work with complex 3D models
- Collect large data sets faster
- Visualize and manipulate complex 3D models more easily
- Work day or night efficiently

#### Components

- Trimble Siteworks Software
- Trimble TSC5 or TSC7 Controller or T7 Tablet
- Trimble R780 or SPS785 GNSS Smart Antenna

### For Supervisors

The **Trimble Siteworks Positioning System for Supervisors** includes Siteworks Software, the R780 or SPS785 GNSS Smart Antenna and either T7 Tablet or T100 Tablet.

#### Key Features

- Run full office software packages, including Trimble Business Center and Microsoft Office
- Work easily with data and 3D models in the field
- Leave the laptop in the office

#### Components

- Trimble Siteworks Software
- Trimble T7 or T100 Tablet
- Trimble R780 or SPS785 GNSS Smart Antenna



## THE TRIMBLE CONTROLLERS

Both Trimble TSC5 and TSC7 Controllers are wirelessly connected, rugged handheld controllers for GNSS or total station operations. They offer a built-in camera and GNSS in a shock, dust and water resistant package.

- Easy to grip and carry ergonomic design for less handling fatigue
- Bright, anti-glare touchscreen for finger, stylus, or gloves helps get more done in sunlight or low light conditions
- Easily enter data in the field using the backlit QWERTY keypad, featuring wide key spacing

**The TSC7 Controller** gives construction surveyors, grade checkers, and site engineers total control over their on-site tasks. With the processing power of a laptop, this handheld controller with a large 7-inch screen is designed for construction site operations and offers integrated Wi-Fi and Bluetooth®. Powerful with its Windows 10 operating system, the TSC7 can run third-party applications as well as Trimble Siteworks Software.

**The TSC5 Controller** is the dependable, modern, next-generation survey controller that enables you and your team to get the job done efficiently and accurately, every day, all day. This Android™-based survey controller features a 5-inch screen and full keyboard that ensures fast, efficient operation, even while wearing gloves. Rugged yet lightweight, with all-day battery power, the TSC5 controller is easy to use for on-site tasks.



## THE TRIMBLE TABLETS

Both the Trimble T7 and Trimble T100 Tablets are built tough to withstand the harsh conditions on a construction site. Unlike modern consumer-grade tablets, they come with IP65-rated military-grade ruggedness certification and withstand anything the elements throw at you.

- Long-life internal batteries ensure hours of field computing
- Sunlight readable display lets you read text, graphics and complex 3D models under any field conditions
- Standardized USB-C ports for charging and data allows for more flexibility

**The T100 Tablet** brings the advantages of fast computing power and a large screen to the field. Integrated GNSS capabilities close the gap between office design and field implementation for design changes, instant approvals and fast communication of changes to field crews. Rapid processing of maps, satellite imagery and image data ensures the T100 won't slow you down.

**The T7 Tablet** is a lightweight, rugged handheld controller for GNSS or total station operations. The easy-to-use T7 Tablet allows contractors to work with larger, more complex 3D data sets more effectively in the field. From the field, to the truck cab, to the office, users stay connected, work more and drive less.



## TRIMBLE EMPOWER PLATFORM

With Trimble Empower Modules, get more out of your Trimble TSC5 and TSC7 Controllers, or Trimble T7 and T100 Tablets. Extend the usability of your Trimble Empower-enabled field devices for a faster return on investment. With support for a range of different correction sources, Empower modules have everything you need to turn your rugged field device into a complete data collector.





# TRIMBLE SMARTER RECEIVERS

FOR CONSTRUCTION SURVEYING OR MACHINE CONTROL APPLICATIONS

## TRIMBLE SPS785 GNSS SMART ANTENNA

The lightweight and compact SPS785 is a fully capable GNSS receiver, featuring proven Trimble quality and accuracy priced for a faster return on investment. The SPS785 is a budget-friendly option to quickly grade check, navigate to points, easily execute simple positioning tasks and record features with attributes, pictures and volumes. The SPS785 can be used as a base or rover.

## TRIMBLE R780 GNSS SMART ANTENNA

The R780 is engineered to stand up to the most dynamic and rugged job site measurement applications. Full GNSS tilt compensation makes Siteworks easier to learn for beginners and saves significant time for more experienced surveyors. Using the R780, construction surveyors can capture accurate points without leveling the pole while standing, walking or driving the site in a vehicle. Tilt compensation in vehicle mode is designed to capture higher accuracy measurements on steeper slopes from a moving vehicle, and more accurate volume measurements to save time and money on material planning.

- Easily and safely survey hard to reach areas (corners, traffic lanes, utility lowlines)
- Faster measurements
- More efficient stake-outs
- Minimal magnetic interference

Both antennas support all constellations for better satellite coverage no matter where you are working.



# TRIMBLE SITE POSITIONING SYSTEMS

## TRIMBLE DA2 GNSS SMART ANTENNA

The lightweight and compact DA2 is a high performing software-based digital GNSS antenna, featuring proven Trimble quality. The DA2 works with Siteworks and SiteVision software on a subscription based service model to deliver centimeter accuracy. The subscription option provides access to reliable, highly accurate internet- or satellite-delivered corrections to suit your business needs, all for a low fixed monthly price and no large upfront capital expense.

- Paired with Trimble Siteworks Software, the DA2 is a budget-friendly option to quickly grade check, navigate to points, easily execute simple positioning tasks and record features with attributes, pictures and volumes to be more efficient in the field.
- Combined with Trimble SiteVision Software, an augmented reality solution, the DA2 allows you to visualize your site. Collect data and bring it to life, see the design in the field throughout all stages of the construction lifecycle.



## TRIMBLE R750 GNSS MODULAR RECEIVER

Whether you need a reliable GNSS base station or a rugged rover, the R750 gives you the connectivity, flexibility and scalability to meet the exact needs of your GNSS-based workflow. As a permanent or semi-permanent base station, it provides GNSS corrections for site measurements and machine control. As a vehicle-mounted rover it can be used for fast, effective grade checking and surface mapping. The R750 receiver can access all available satellite signals and provides improved performance and reliability in challenging GNSS conditions using constellation-agnostic Trimble ProPoint™ technology.

Reliably transfer data from the field to the office to keep everyone on the same page. The fully upgradable R750 can be configured in a variety of ways to suit your job site requirements in a wide variety of civil and marine construction applications. Simply purchase the receiver that you need today, and upgrade as your needs change:

- As a precise RTK base station only
- As a precise rover only
- As a flexible precise base or rover with Precision RTK accuracy



## GNSS RADIOS

Trimble radios offer flexible configuration options and rugged reliability for efficient use of GNSS on the construction site.

- Easy setup and configuration, even in the field
- Reduces unnecessary inventory—do more with less
- Provides more flexible operation
- Streamlines field configuration and troubleshooting for maximum productivity
- Access to diagnostic data in the field
- Modify power as conditions require - dialing up the power for longer baselines and when the work area is smaller, a lower-power output extends battery life
- Built to endure the stresses of daily use in harsh construction conditions
- Fully sealed against dust, rain, splash, and spray for optimal reliability in all weather conditions to minimize downtime and lower overall operating costs



# TRIMBLE TOTAL STATIONS

## FULL RANGE OF ROBOTIC AND UNIVERSAL TOTAL STATIONS

Keep it accurate, but keep it simple. The Trimble SPS620 and SPS720 Robotic Total Stations are perfect for one-person operation on smaller site operations and work on structures such as bridges or culverts, offering very high accuracy and reliability for construction site positioning, stakeout and measurement.

Trimble SPS Robotic total stations are well suited for use on:

- Smaller construction sites or combined with GNSS on larger sites
- Tasks where the accuracy requirements are tight
- Measuring dangerous or inaccessible locations

No matter what job you are doing, Trimble robotic total stations will deliver unmatched user experience, all-around capability and incredible results, priced for a quick return on investment.

## UNIVERSAL TOTAL STATION

The Trimble SPS730 and SPS930 Universal Total Stations can tackle any measurement, stakeout or machine control task on the job site — all from the same instrument.

**Trimble MultiTrack™ technology** locks on and tracks passive prisms for monitoring or control measurements and active targets for dynamic measurement, stakeout and grade control. Active targets guarantee lock to the correct target, especially in dusty construction site conditions. Up to 16 unique channels of target identification can be used to differentiate survey crews and grade checkers from machines, eliminating downtime caused by unnecessary interference.

**Trimble's patented MagDrive™ servo technology** utilizes magnetic levitation to eliminate friction. Fast response time and fast servos allow the instrument to change direction, and track more reliably. Trimble Universal Total Stations can provide highly accurate machine guidance for excavation, grading, compaction, milling, and paving projects. Using the same Trimble total station, your machines can work to tight construction tolerances, save expensive materials, avoid rework and get to grade faster.



Robotic, reflectorless and machine control features satisfy all site positioning and machine control needs

Industry-leading 20 Hz dynamic positioning update rate

Robotic and reflectorless features satisfy most site positioning needs

Active target function guarantees reliable lock on the correct target

DR Plus long-range reflectorless measurements eliminate the risk and delay of walking the surface with a target

Trimble MagDrive servos provide unmatched instrument turning and tracking speeds

# TRIMBLE SX12 SCANNING TOTAL STATION

THE ALL-IN-ONE SURVEY TOTAL STATION AND SCANNER

The Trimble SX12 Scanning Total Station is a state of the art combination of total station and scanner, and the first of its kind on the market. This one instrument enables you to benefit from the same workflows from a robotic total station, but also the high-end 3D laser scanning and imagery functionalities.

Get more done in the field by capturing the entire site through point clouds and images, rather than just individual points of interest. With the SX12 you can get everything you need from a site, and more, in just minutes; saving you hours or days of surveying. With the additional site information from scan data, images and point clouds you can avoid re-work and costly site revisits.



# SAVE TIME, MAXIMIZE EFFICIENCY

## A ROBOTIC TOTAL STATION, AND MORE

Achieve high accuracy and reliability for construction site positioning, stakeout and measurement without the need for a separate device onsite. This powerful combination of high accuracy surveying and 26,600 points-per-second 3D scanning is a game changer.

## REACH THE INACCESSIBLE

Rapidly collect millions of points and dozens of photos to effectively capture reality for accurate as-builts in inaccessible locations. A great option for safer surveying and avoiding the hassle and time involved in gathering data from dangerous or difficult to reach locations.

## VIVID, EYE-SAFE LASER POINTER

The green laser pointer is exceptionally small, bright, and still eye safe—with auto focus functionality.



## WITH THE SX12 YOU CAN:

- Collect millions of points rapidly
- Perform site surveying measurements
- Grade checking for inspection and monitoring
- Safely and efficiently scan road surfaces, intersections, embankments and other structures
- Capture rich, accurate and complete geometrical and visual documentation of as-builts



## CAPTURE REALITY

With the video enabled workflow, it is much easier and faster to find yourself if you lose tracking and to zoom in and aim at different points for DR shots. The four built-in, high quality cameras with huge zoom allow you to capture a range of imagery.

- Capture reality with point clouds for accurate as-builts in inaccessible locations
- Geo-reference images of the site to record conditions in real-time
- Live site footage for remote control and monitoring on construction sites
- Eliminate the need for a separate camera on site



## TRIMBLE MARINE CONSTRUCTION (TMC) SYSTEMS

Improve productivity and efficiency in underwater marine construction applications including dredging, crane operations, piling and hydrographic survey. TMC provides accurate 3D visualization to assist the operator with underwater construction tasks.

Ask about optional integrated sonar for real-time verification.

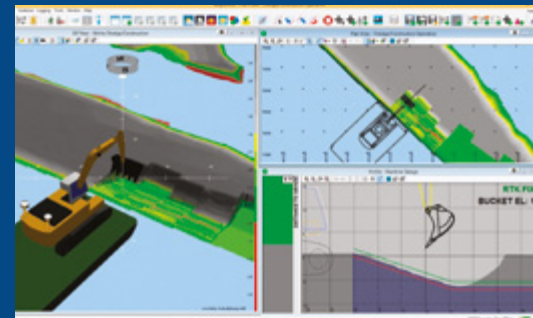

## OUR MARINE SYSTEM APPLICATIONS INCLUDE:

- Dredge positioning and guidance (Backhoe Excavator, Bucket Dredger, Cutter Suction Dredger, new Trailing Hopper Suction Dredger, Grab/Clamshell Dredger)
- Placement (Coastal Defence Rock Dumping and Placement, Caisson Placement, Block Placement using Wire crane or Excavator, Vertical and Raked pile placement)
- Hydrographic survey (Single beam or Multibeam) environmental data collection for applications such as channel maintenance, dredging progress, environmental surveys, and bed erosion
- Positioning and tracking of barges, tugs and other construction vessels

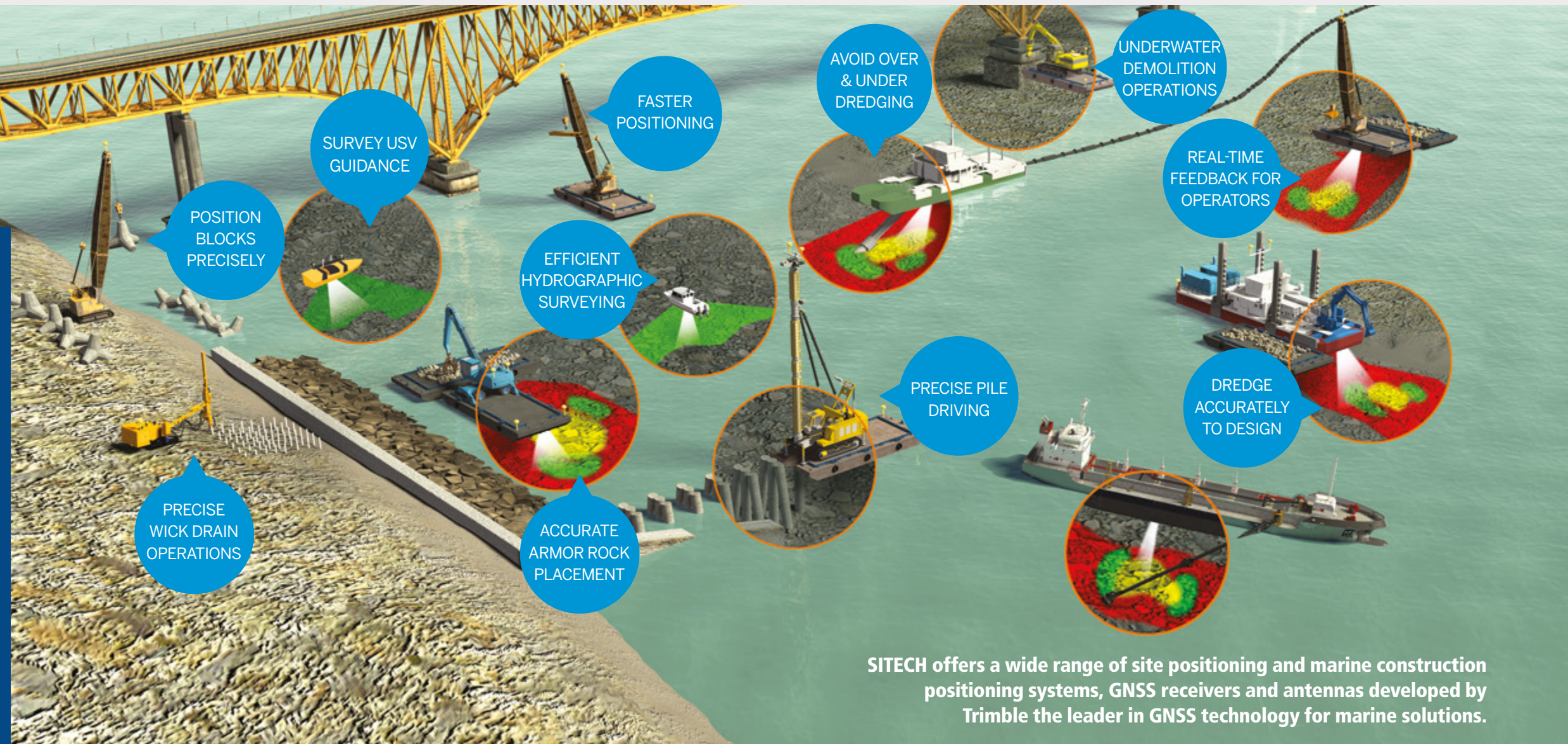

SITECH offers a wide range of site positioning and marine construction positioning systems, GNSS receivers and antennas developed by Trimble the leader in GNSS technology for marine solutions.

### TRIMBLE MPS566 MARINE GNSS

The Trimble MPS566 is a highly versatile, rugged and reliable Global Navigation Satellite System (GNSS) marine positioning solution. Features maximum connectivity—Bluetooth, Wi-Fi, UHF radio, cellular modem and two MSS satellite correction channels.



### GNSS MODULAR RECEIVERS

Save time, money and headaches with the R750 connected base station solution, includes remote monitoring and alert: an internal radio and rover capability.



The BX992 GNSS Heading Receiver is a dual-antenna GNSS receiver offering precise heading capability and multi-frequency support for all known constellations.

### GNSS ANTENNAS

Trimble offers several models of GNSS antennas to suit your specific application, signal tracking and budget requirements including the SPS785 and R780.



### GNSS CORRECTION SOURCES

Your GNSS operations are only as good as your correction source. It's important, so we let you choose the right one for you. Larger sites may need a local GNSS base station for the highest precision, smaller sites may opt for a virtual correction source.

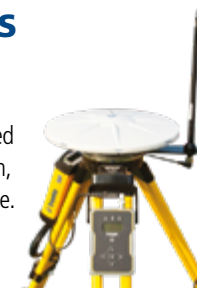

### MARINE INERTIAL POSITIONING SYSTEM

The Trimble Marine Inertial Positioning System is a compact dual antenna system that provides robust and precise 3D position and orientation data in the most challenging of marine environments.



### GNSS RADIOS

Trimble radios offer flexible configuration options and rugged reliability for efficient use of GNSS on the construction site.



# CLEAR 360 PRO HEADSET

FOR JOB SITE SAFETY AND PRODUCTIVITY

# SAFETY FIRST



## HOW IT WORKS:

- Passive protection: the foam tips provide hearing protection by reducing all sound by approximately 24dB (NIOH safe level 85dB, OSHA safe level is 90dB)
- Real-world sounds are presented naturally and at a safe volume level: the microphone, processor and speaker transmit the same real-world sounds that would be heard without protection, but at safe dB level
- 360 auditory situational awareness: provides the ability to clearly and accurately locate the direction that sounds are coming from
- Bluetooth connections: cell phones / radios allow key personnel to communicate clearly and safely in harsh sound environments
- Custom listening modes: four user selectable profiles plus mute optimize safety and communication in different noise environments



## FEATURES YOU WILL LOVE



16-hour  
Battery



IP-64 Water &  
Dust Resistant



24 NRR  
Protection



Bluetooth  
5.0



Five Listening  
Modes



360° Auditory  
Situational  
Awareness

Clear 360 Pro features superior hearing protection from loud sounds, both continuous and transient, extraordinary 360° auditory situational awareness, and simultaneous Bluetooth® communication capabilities. Patented voice frequency processing improves speech intelligibility in high noise environments to improve communications and production.

The Clear 360 Pro's patented sound processing places emphasis on enhancing human speech (voice frequencies) so conversations, communications and warnings are now possible in loud environments.



## BENEFITS:

- Protect the user's hearing from sustained excessive sound levels like a jack hammer or construction machinery, and dangerous impact sounds like dropped steel on concrete
- Reduce construction site "struck-by" injuries and fatalities caused by a lack of hearing. This device provides the user with 360° auditory situational awareness; the user knows the direction of all sound so they can hear and avoid known dangers such as a truck approaching from behind, backup alarms, verbal warnings, etc.

## ADDITIONAL FEATURES:

- 16-hour battery, fast recharge
- 2.5-ounce total weight
- Choice of yellow or gray
- Rugged storage case
- 2-year warranty

## ACCESSORIES INCLUDED:

- AC Charging Block and Cable
- Foam Tips – small, medium and large
- Ear Wing – small, medium and large
- Wind Screen – replacement
- User Manual



# TRIMBLE WORKS PLUS SUBSCRIPTION

CONNECTED CONSTRUCTION FOR A LOW MONTHLY PRICE

# FLEXIBLE TECHNOLOGY SOLUTION

TO FIT YOUR BUSINESS

Trimble Works Plus Subscription is an all-inclusive connected construction solution with a low, fixed monthly price including installation, hard-\* and software upgrades, repairs and world class service and support from SITECH.

With a low fixed monthly price and local SITECH installation and support, Works Plus will help you quickly optimize your construction technology program. Upgrade to the latest hardware\* and software for the duration of your agreement, including a full factory warranty and repair or replacement of accidentally damaged hardware.



## YOUR ADVANTAGES ARE CLEAR:

- Modernize your fleet without a large initial investment—obtain the goods you need without affecting your cash flow
- Works Plus ensures the latest technology and software versions
- More accurate bids as the technology cost is fixed and known
- Soft entry into the digital world, data management and utilization is included (productivity, usage, maintenance etc.) depending of the software chosen
- You no longer assume the risk of product failure or responsibility for maintenance—your hardware and software is always covered
- The first and only construction technology subscription of its kind that allows you to forever proof your business on your terms

## Conventional purchase vs. Works Plus comparison:

PURCHASE OPTION	PURCHASE	WORKS PLUS SUBSCRIPTION
System	Machine – Base / Rover	Machine – Base / Rover
Warranty – Field Service	1 Year included	Included
Accidental Damage – Includes cables	Optional	Included
New Component Upgrades	No	Yes*
Data Plan	Optional	Included
Hardware Owned	Yes	Yes
Software / Codes Owned	Yes	Subscription

\* Once per device per term.

## BASED ON YOUR NEEDS, CHOOSE ANY COMBINATION OF BUNDLES:

### ON MACHINE



Single Machine Type

Move your grade control system across similar machine types



Flexible Machine Types

Move your grade control system to any machine type in your fleet

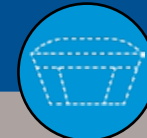

Machine Kits

Prepare any machine for grade control at any moment



In-Cab Kits

Grade control system receivers and in-cab display

### OFF MACHINE



Base

Trimble base station to create reliable reference data



Data Collector

Rugged controllers for GNSS or total station operations



Data Collector and Rover

Best-in-class Trimble construction survey system



Universal Total Station

Highest degree of accuracy for precision operations

### SOFTWARE



Office

Data prep, design, modeling tools, asset tracking

### ADD-ON PACKAGES



Extended Support Plan

Fixed-price service agreement options for ongoing product support



Augmented Reality (Excavators Only)

View 3D models in the context of existing surroundings



Auto Excavator (Hydraulic Kit)

Automatically control boom and bucket, guiding to 3D models or 2D surfaces



Payload Management

Track bucket-by-bucket payload and monitor mass haul productivity

# TRIMBLE PROTECTION PLANS

PREMIUM OR PLUS

You buy Trimble construction hardware and software because you know you can count on Trimble solutions to get the job done. Your Trimble equipment comes with a factory warranty that is our promise to you that we stand behind our Trimble products. Because we understand that you may want to continue to use your Trimble equipment beyond the warranty period, Trimble offers additional coverage with Trimble Protected Premium\* and Trimble Protected Plus protection plans. These protection plans make good business sense and are an excellent way to protect your cash flow and minimize the risk of doing business.



## TRIMBLE PROTECTED PREMIUM\*

### FIVE FULL Years of Coverage Plus Accidental Damage\*

Trimble Protected Premium is a multiyear plan that supplements the factory warranty to provide you with FIVE YEARS of coverage for drops, falls, liquid spills, broken screens, and similar types of damage resulting from an accident. The Accidental Damage\* coverage is in addition to instrument failures. No matter whether you need a warranty-type repair, your instrument broke as the result of an accident or you just want to buy coverage once and then be worry-free for five years, Trimble has you covered!

Available for purchase only at the product point of sale, Trimble Protected Premium coverage begins immediately and runs concurrently with the factory warranty and throughout the protection plan period. Trimble will either repair the instrument OR replace the instrument with a new or like new instrument if the unexpected should happen.

Trimble Protected Premium is available on Trimble Earthworks, Trimble Roadworks and Trimble Site Positioning Systems. Trimble Protected Premium also includes firmware updates for GNSS receivers, Siteworks Software for SPS Data Collectors and Tablets, and cables and connectors for Trimble Earthworks systems.

### Value Add Features of Both Plans

Our protection plans' value comes in the additional features and benefits available to you as long as you own the coverage. Our protection plans' value add features include:

- Preventative maintenance (adjustments and calibrations - see your distributor for details)
- Protection against wear and tear from repetitive use that causes your equipment to not function to specification. For example:
  - If the part can no longer perform the function to which it was designed solely because of its condition (due to usage), it's covered by wear and tear
  - Cosmetic damage that does not affect the functioning of the unit is excluded from wear and tear coverage
- Equipment damage protection from surges when using Trimble power supplies
- Protection from environmental damage from dust, heat, humidity and salt air when used in accordance with intended equipment specifications

\* On select hardware only. Not available in all countries or regions. See your Trimble Protected protection plans distributor for availability.

# PROTECT YOUR INVESTMENT

FROM THE HAZARDS OF EVERYDAY WORK

## TRIMBLE PROTECTED PLUS

### Enhance and sustain your entire ownership experience

A Trimble Protected Plus protection plan covers everything that is covered in your original Trimble hardware factory warranty and includes our Value Add features. If the unexpected happens and your equipment has to be repaired, that's no problem! Your protection plan ensures that you pay nothing out of pocket for parts and labor on covered repairs. There's also no deductible or fee associated with covered repairs.

When you sign up today for a Trimble Protected Plus protection plan, you can look forward to lapse-free coverage after your factory warranty has expired. If your equipment is not covered by a factory warranty or a protection plan now, you can bring that equipment back under coverage with a Trimble Protected Plus Reinstatement protection plan.

### Overall Benefits of the Trimble Protected Plans:

- An annual protection plan generally costs less than the average repair cost
- Our Trimble Protected coverage entitles you to a new piece of equipment with comparable features if yours can't be fixed, or if it simply makes more sense to replace it
- Our plans are backed by Trimble's quality parts and quality repair service; a value you can trust. Trimble wants to keep you as a satisfied protection plan customer for life so we guarantee to stand behind you and your product for as long as you own your coverage
- Repairs are typically completed faster because there's no need for your distributor to generate an estimate and get your approval before starting work
- Protection plans are money and time savers
- Locks in tomorrow's repair costs at today's prices
- A protection plan keeps you running, minimizes unnecessary downtime and improves your overall efficiency



# SITECH SERVICES

YOUR LOCAL PARTNER



## SERVICE CENTER

As a Trimble Authorized Service Provider, we offer a wide range of technical services, all conducted by highly qualified technicians utilizing professional tools and highly precise equipment. Unforeseen repair and service costs and downtime can be significantly reduced through periodic calibration and preventative maintenance, and you benefit from equipment that is always in top condition. The broad service offering includes certification services, repairs and product upgrades.



## TRAINING

Trimble construction technology is a game changer – and to benefit from all its power, you want to make sure to take advantage of SITECH's expert professional training.

Whether you and your crew are new to machine automation, you need a refresher or there are team members who have recently joined, let's talk and make sure you get the right training.

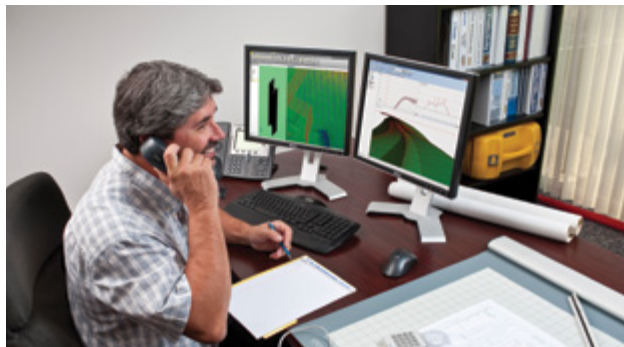

## SITECH SUPPORT

Our Support Team is dedicated to making sure your downtime is kept to a minimum. We have office based staff, just a phone call away 24/7. Many issues can be resolved over the phone or with Trimble Remote Connect.



## RENTAL

Get what you need, when you need it. Take advantage of our various rental programs to dip your toes – you'll get the job done right and you'll experience the benefits of the newest state of the art technology, while you take your time to make the final decision.

During your rental period, if you realize that you don't want to give up the value you have just discovered, there's an answer for you, our convenient rental conversion.

## People and technology you can rely on.

SITECH is the leading distributor of easy-to-use, proven Trimble technology for construction companies of all sizes. From Trimble machine control systems to site positioning systems and construction office software—with SITECH you will find the right support, knowledge and experience to increase your productivity and profitability through the use of powerful and connected technology.









## Western Region

**Valérie Blanchenay**

Field Marketing Manager - Western America

303.489.4496

[valerie\\_blanchenay@trimble.com](mailto:valerie_blanchenay@trimble.com)

## Eastern Region

**Alex Foley**

Field Marketing Manager - Eastern America

303.483.8496

[alex\\_foley@trimble.com](mailto:alex_foley@trimble.com)

## ● SITECH Dealerships

